

POÊLES
CHAUDIÈRES
CHEMINÉES

KACHELS_KETELS_HAARDEN
ÖFEN_HÉIZKESSEL_KAMINE
STOVES_BOILERS_FIREPLACES

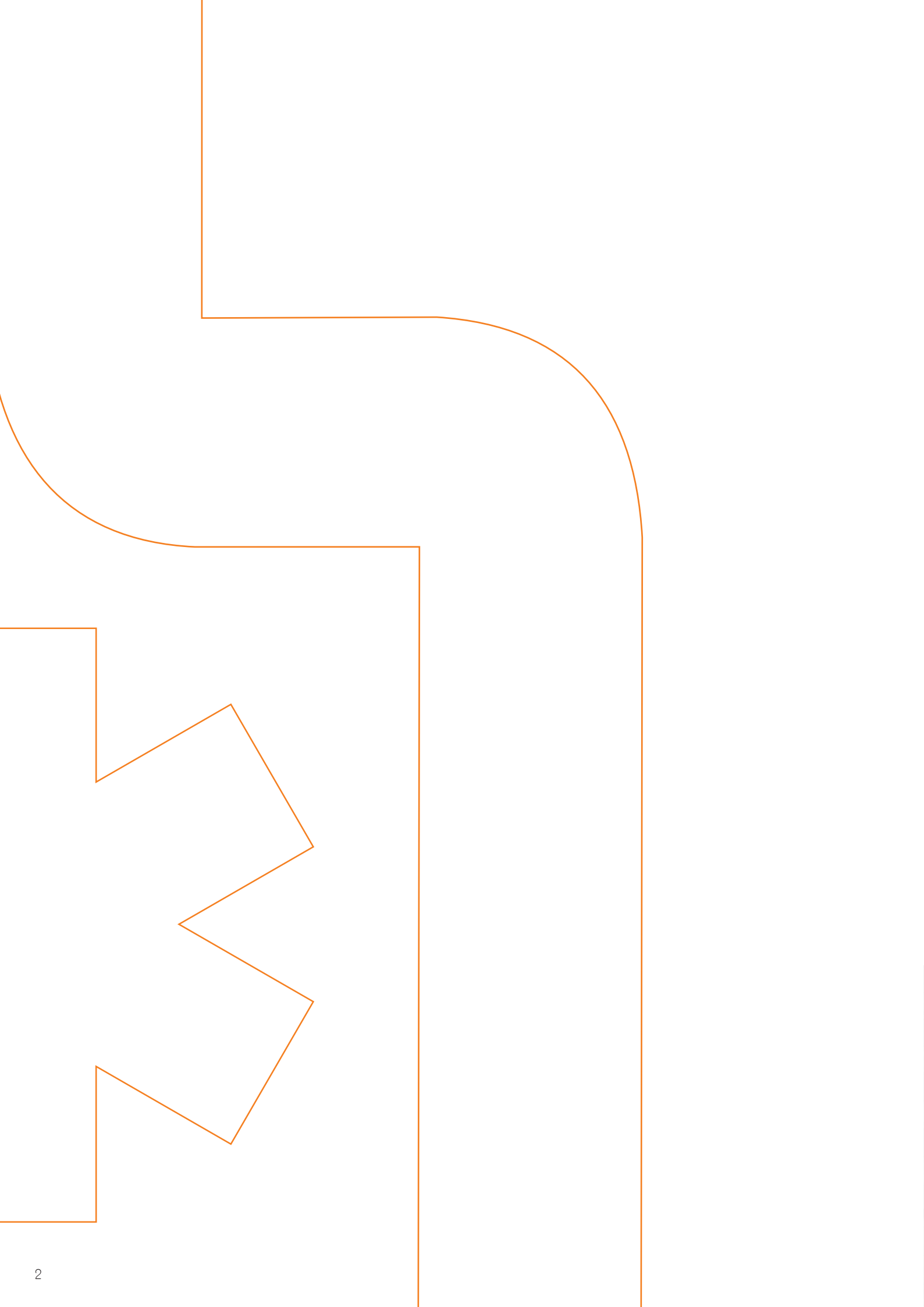

EDILKAMIN

DEPUIS 50 ANS, LE CHOIX DE LA CONFIANCE

Edilkamin est un groupe qui comprend plus de 400 employés, plus de 80 agents commerciaux et plus de 400 centres d'assistance technique. Depuis toujours attentif aux exigences d'un marché en perpétuelle évolution, Edilkamin propose des solutions à l'avant-garde de la technologie, qui se distinguent par un design particulièrement soigné afin de répondre aux besoins les plus modernes.

L'objectif consiste à offrir ce qu'il se fait de mieux en termes de fiabilité et de sécurité. Edilkamin exporte avec brio la technologie et le design qui lui ont valu sa réputation dans plus de 30 pays.

AL 50 JAAR EEN BETROUWBARE KEUZE

Edilkamin is een groep met meer dan 400 werknemers, meer dan 80 handelsvertegenwoordigers en ruim 400 technische assistentiecentra.

Dankzij de onaflatende aandacht voor de eisen van een markt die voortdurend in ontwikkeling is, biedt Edilkamin technologisch geavanceerde oplossingen met een uiterst verzorgd design, in lijn met de modernste eisen.

Edilkamin exporteert met succes technologie en design naar meer dan 30 landen.

SEIT 50 JAHREN EINE ZUVERLÄSSIGE WAHL

Edilkamin ist eine Unternehmensgruppe mit über 400 Mitarbeitern, mehr als 80 Vertriebsagenten und über 400 Kundendienstzentren.

Edilkamin achtet seit jeher auf die Bedürfnisse eines sich ständig weiterentwickelnden Marktes und bietet technologisch fortschrittliche und besonders sorgfältig entworfene Lösungen an, um den modernsten Anforderungen gerecht zu werden. Edilkamin exportiert erfolgreich Technologie und Design in mehr als 30 Länder.

A TRUSTED BRAND FOR OVER 50 YEARS

Edilkamin is a group employing over 400 people, with more than 80 sales agents and over 400 technical assistance centres.

Ever careful to the needs of a continuously evolving market, Edilkamin proposes technologically advanced solutions featuring sophisticated design, in line with contemporary necessities.

Edilkamin exports technology and design with success to over 30 countries worldwide.



EDILKAMIN IN Europa



2 LAVAGNO (Verona)

Pôle technique et laboratoire de Recherche et Développement.

Technische centrum en onderzoek & ontwikkelings lab.

Technisches Forschung-und Entwicklungslabor.

Technical Centre and Research & Development Lab.

3 GABBIONETA BINANUOVA (Cremona)

Unité de fabrication et Recherche & Développement pour l'obtention des nombreuses et importantes certifications.

Productie-unit en afdeling Research & Development, belast met het verkrijgen van belangrijke certificeringen.

Produktionsstandort und F&E für die Erlangung der Konformität der Produkte mit maßgeblichen Zertifizierungen.

Production Unit and Research & Development Unit for obtaining important certifications.

4 NUVOLERA (Brescia)

Site spécialisé dans le travail du marbre.

Gespecialiseerde marmmerwerkplaats.

Spezialabteilung für die Bearbeitung von Marmor.

Laboratory specialised in marble processing.

5 CONTROGUERRA (Teramo)

Centre logistique pour la gestion des services en Italie centrale et du sud.

Logistiek centrum voor het beheer van de diensten in Midden en Zuid-Italië.

Logistik und Vertriebszentrum für Mittel und Süditalien.

Logistics centre for managing services in Central-Southern Italy.



1 LAINATE



Siège central, Divisions commerciales, Marketing, Administration, Information & Technology, Salles de classe pour les formations techniques et commerciales, Hall d'exposition de plus de 1000 m² où toute la gamme est présentée.

Hoofdkantoor, Commerciële instellingen, Marketing, Administratie, Information & Technology, ruimten voor technische en verkooptrainingen, showroom van meer dan 1000 m² waar het hele productenaanbod tentoongesteld wordt.

Hauptsitz, Vertrieb, Marketing, Firmenverwaltung, Information & Technology, Räume für Technik- und Verkaufsschulungen, Showroom auf mehr als 1000 m² Fläche mit dem gesamten Produktangebot in permanenter Ausstellung.

Head office, Sales and Marketing divisions, Accounts, Information & Technology departments, classrooms for technical and sales training, and showroom covering over 1,000 m² with the complete range on display.

8

9

6 GERONA (Spagna)

Edilkamin Iberica, commercialisation Espagne et Portugal

Edilkamin Iberica, verkoop in Spanje en Portugal

Edilkamin Iberica, Vertriebszentrale für Spanien und Portugal.

Edilkamin Iberica, commercialisation centre for Spain and Portugal

7 SARVAR (Ungheria)

Edilkamin International, unité de fabrication

Edilkamin International, productie-unit

Edilkamin International, Produktionsstandort

Edilkamin International, production unit

8 BUDAÖRS (Ungheria)

Edilkamin International, Show room.

Edilkamin International, Show room.

Edilkamin International, Show room.

Edilkamin International, Show room.

9 ATENE (Grecia)

Edilkamin Hellas, Hall d'exposition et commercialisation Grèce.

Edilkamin Hellas, Showroom en verkoop in Griekenland.

Edilkamin Hellas, Showroom und Vertriebszentrale für Griechenland.

Edilkamin Hellas, showroom and commercialisation centre for Greece.



EDILKAMIN SIEGE **CENTRAL**

HOOFDKANTOOR_HAUPTSITZ_HEAD QUARTERS



Grand hall d'exposition

Le siège de Lainate abrite un large hall d'exposition réparti sur trois étages : 1000 m² où est présentée l'intégralité de la gamme Edilkamin dans un contexte d'avant-garde et avec des produits en fonctionnement.

Ruime showroom

Bij de vestiging in Lainate is een uitgebreide tentoonstelling ondergebracht die drie verdiepingen beslaat en een oppervlak van 1000 m², waar het hele aanbod van Edilkamin gepresenteerd wordt in een geavanceerde context met functionerende producten.

Umfangreicher showroom

Im Hauptsitz in Lainate präsentiert Edilkamin in einer Hausausstellung auf drei Etagen mit insgesamt 1000 m² Fläche das gesamte Produktprogramm in einem modernen Ambiente und mit voll funktionierenden Geräten.

Extensive showroom

Lainate Headquarters hosts an extensive 1.000 m² showroom all over three floors, displaying the entire Edilkamin range in an avant-garde context with working products as well.





Service après-vente
After-sales service
After-sales
After-sales

Le service après-vente est très important : le personnel Edilkamin offre une assistance rapide en cas de nécessité, pour répondre à n'importe quel besoin.

De after-sales ondersteuning is heel belangrijk: het personeel van Edilkamin biedt onmiddellijk hulp wanneer dat nodig is en gaat in op elke behoefte.

Der After-Sales-Service ist ein sehr wichtiger Aspekt: Das Edilkamin Team garantiert einen zeitnahen Kundendienst für alle Anwendungsfälle.

After-sales support is a crucial service: the Edilkamin staff offers timely support whenever required, for responding to any need.

Confiance et fiabilité
Vertrouwen en betrouwbaarheid
Vertrauen und Zuverlässigkeit
Trust and reliability

Edilkamin est aux côtés de ses clients à tout moment, du choix du produit jusqu'à l'installation. De plus, en cas de nécessité, du personnel qualifié est toujours disponible pour répondre à n'importe quel besoin.

Edilkamin staat altijd naast zijn klanten, vanaf het moment waarop een product gekozen wordt tot en met de installatie ervan. Bovendien kan de klant, wanneer nodig, altijd beschikken over gekwalificeerd personeel voor elke behoefte.

Edilkamin begleitet Sie von der Auswahl des Geräts bis zur Installation. Qualifizierte Fachleute sind jederzeit für Sie erreichbar, falls Sie Fragen zu Ihrem Gerät haben.

Edilkamin supports customers throughout all phases, from selection of the product to its installation. Moreover, where required, qualified personnel is always on hand for any need.



Épargne

QUALITÉ ÉCOLOGIE

OPSLAAN, KWALITEIT, ECOLOGIE
SPAREN, QUALITÄT, ÖKOLOGIE
SAVING, QUALITY, ECOLOGY

Tests et traçabilité

Test en traceerbaarheid

Endprüfung und rückverfolgung

Testing and traceability

Chaque produit Edilkamin est testé afin de garantir une efficacité et une fiabilité maximales.

Le système de traçabilité permet de remonter jusqu'au produit, jusqu'à chaque composant et jusqu'au préposé au montage, afin de résoudre les éventuels problèmes dans les délais les plus brefs.

Om de maximale efficiëntie en betrouwbaarheid te garanderen, wordt elk product van Edilkamin getest.

Het traceerbaarheidssysteem maakt het mogelijk om een product, een afzonderlijke component en de montagemedewerker terug te vinden, om eventuele problemen in korte tijd op te lossen.

Jedes Gerät wird bei Edilkamin endgeprüft, um seine maximale Effizienz und einen zuverlässigen Betrieb zu garantieren. Die Rückverfolgung der Produkte ermöglicht, ein Gerät, eine einzelne Komponente oder den zuständigen Mitarbeiter der Montageabteilung ausfindig zu machen und in kürzester Zeit eventuelle technische Probleme zu beheben.

Every Edilkamin product is tested to guarantee its maximum efficiency and reliability.

The traceability system allows for tracking the product, individual component and assembly operator to solve any problems in the shortest possible time.

Tous les produits Edilkamin entrent dans les catégories d'efficacité énergétique

Alle edilkamin producten voldoen aan de gestelde eisen voor de energy efficiency classes

Alle Edilkamin-Produkte fallen in die Energieeffizienzklassen
All Edilkamin products meet the criteria of energy efficiency classes

A⁺⁺, A⁺, A

Selon les règlements de l'UE 2015-1186 / 1187.

Volgens de EU normering 2015-1186/1187

Nach EU-Richtlinien 2015-1186/1187.

According to the UE 2015-1186/1187.

Certification _Certificeringen Bescheinigungen _Certification

Les produits, au besoin, sont certifiés selon les réglementations, en plus du marquage CE:

Buiten de CE-markering worden de producten, in functie van de eisen, tevens gecertificeerd volgens de normen:

Bei Bedarf werden die Geräte zusätzlich zur CE-Kennzeichnung ebenfalls nach folgenden Normen zertifiziert:

As appropriate, products not only receive CE marking but are also certified according to the standards:

- **EN 13229** Foyers _Haarden_Kamineisätze _Fireplaces
- **EN 13240** Poêles à bois _Houtkachels_Kaminöfen _Wood-stoves
- **EN 14785** Poêles à pellet _Pelletkachels_Pellet-Kaminöfen _Pellet stoves
- **EN 303-5** Chaudières _Ketels_Heizkessel _Boilers

• Flamme Verte

Marque de certification française de qualité _Fransé merkcertificatie van kwaliteit_Französisches Zertifizierungszeichen der Qualität _French certification stamp of quality

• Blmsch

Rexigences allemandes pour les appareils de chauffage domestiques _Duitse vereiste kwalificatie voor huishoudelijke verwarmingsapparatuur_Deutsche Anforderungen an Haushaltsfeuerungsgeräte _German requirement for domestic heating appliance

• 15 a B-VG

Loi autrichienne sur les émissions _Oostenrijkse emissiewet _Österreichisches Emissions-Gesetz _Austrian emissions law

• PCT

Certification de produit russe _Russisch productcertificaat
Russische Produkt-Zertifizierung _Russian certification

• BAFA

Du ministère de l'énergie Allemande _Duits Ministerie voor Energie_
Deutsche Förderung von Energie und Klimaschutz _German Energy Ministry

• EKO SKLAD

Ministère slovène de l'énergie _Sloveens ministerie van Energie_
Slovenischen Ministerium für Energie _Slovenian Ministry of Energy.

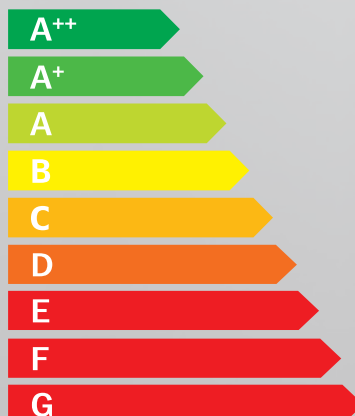

Bois, pellets et multi-combustible:
économique, renouvelable, fiable et efficace

*Hout, pellets en multibrandstof:
zuinig, duurzaam, veilig*

Holz, pellet und mehrbrennstoffe:
preiswert, umweltfreundlich, sicher

*Wood, pellet and multi-fuel:
competitive, eco-friendly, safe*



POURQUOI LE BOIS?

C'est simple à trouver
C'est naturel
C'est le combustible le plus économique et le plus écologique



POURQUOI LE PELLETS?

C'est simple à employer
Il à une très haute valeur calorifique
Il permet une régulation automatique
Il permet de programmer des différentes fonctions



POURQUOI LE MULTI-COMBUSTIBLE?

C'est naturel
C'est en utilisant des déchets de production, initialement destinés à la destruction
Il permet une gestion automatique



WAAROM HOUT?

*Het is makkelijk te vinden
Het is natuurlijk
Het is de goedkoopste brandstof
Het geeft een warme sfeer*

WAAROM PELLETS?

*Ze zijn gebruiksklaar
Ze hebben een hoge energiewaarde
Geschikt voor automatische werking
Geschikt voor programmering van de verschillende functies*

WAAROM MULTIBRANDSTOF?

*Het is natuurlijk
Het is makkelijk te vinden
Het is afval van productieprocessen, dat anders afgevoerd zou worden
Het kan makkelijk opgeslagen worden
Geschikt voor automatische werking*

WARUM HOLZ?

Es ist leicht zu finden
Es ist ein natürlicher Rohstoff
Es ist der günstigste Brennstoff
Es bringt eine gemütliche Stimmung

WARUM PELLETT?

Es ist einfach zu verwenden
Es hat einen hohen Heizwert
Es ermöglicht eine automatische Regulierung
Es ermöglicht die Regelung von verschiedenen Funktionen

WARUM MEHRBRENNSTOFF?

Ist ein natürlicher Rohstoff
Ist leicht aufzufinden
Er ist Abfall von Produktionsprozesse, welcher sonst zu entsorgen wäre
Er ermöglicht eine automatische Steuerung

WHY WOOD?

*It's easy to find
It's a natural raw material
It's the cheapest fuel
It offers a very suggestive environment*

WHY PELLETT?

*It's easy to use
It has a very high calorific power
It allows an automatic regulation
It allows to program different functions*

WHY MULTI-FUEL?

*It's a natural raw material
It's easy to find
It's waste of production processes
It allows an automatic use*

Technologie EN ÉVOLUTION

EEN EVOLUERENDE TECHNIEK
SICH ENTWICKELNDE TECHNOLOGIE
AN EVOLVING TECHNOLOGY



Edilkamin
SMS



appFire



WiFire



Avec les app Edilkamin, gérez votre chauffage à granulés peu importe où vous soyez.

Les applications créées par Edilkamin permettent de gérer toutes les fonctions de base d'un appareil à granulés depuis un smartphone ou une tablette. Pour utiliser appFire ou Wifi, il suffit de disposer d'une connexion de données disponible. En l'absence d'une connexion, il est possible d'utiliser l'App Edilkamin SMS, qui requiert uniquement une connexion téléphonique. Achetez le module WiFi et téléchargez dès maintenant votre application (vérifiez sur la fiche technique du produit que vous avez acheté l'application que vous devez télécharger).

Met de apps van Edilkamin beheer je je pelletverwarming, waar je ook vind.

Met de (app en het) wifi module van Edilkamin kunnen alle basifuncties van een pelletkachel worden bediend met behulp van een smartphone of tablet. Om appFire of Wifi te gebruiken moet er een dataverbinding beschikbaar zijn. Bij gebrek aan een dergelijke verbinding kan de app Edilkamin SMS worden gebruikt, waarvoor slechts een telefoonlijn nodig is. Koop de WiFi-module en download meteen je app (kijk op de technische kaart van het gekochte product welke toepassing je moet downloaden).

Mit den Edilkamin APPs steuerst du deine Pelletheizung, wo auch immer du bist.

Die Edilkamin APPs ermöglichen, mit allen Grundfunktionen von einem Pelletprodukt mit der Benutzung eines Smartphones oder Tablet. Zur Nutzung von appFire oder Wifi muss eine Datenverbindung zur Verfügung stehen. Wenn dies nicht möglich ist, kann die App „Edilkamin SMS“ verwendet werden, die lediglich eine Telefonverbindung benötigt. Kaufe das Wi-Fi Modul und lade sofort deine App herunter. (überprüfe auf dem technischen Datenblatt vom erworbenen Produkt, welche App herunterzuladen ist).

The Edilkamin apps allow you to manage your pellet heating system wherever you are.

The Edilkamin applications allow for managing all the basic functions of a pellet-burning product using a smartphone or tablet. In order to use Wifi or Appfire, you need to have a data connection. If not available, you can use the sms edilkamin app and just a simple telephone line. Purchase the Wi-Fi module and immediately download your app. (check the application to be downloaded on the technical sheet of the purchased product).



Nouvelle radiocommande: meilleur sensibilité tactile, éclairage latéral à led désactivable et meilleures performances avec la fonction Night élargie.

Nieuwe radiobesturing: betere tactiele feedback, uitschakelbare led-zijverlichting en betere prestaties met de uitgebreide Night-functie.

Neue Funkfernbedienung: besseres Feedback der Tasten, seitliche deaktivierungsfähige LED-Beleuchtung, höhere Leistungsfähigkeit mit erweiterter Night-Funktion.

New remote control: better touch response; led side lighting (can be disabled as well); best performances by the improved night mode.



Radiocommande_Afstandbediening_Funkfernbedienung_Remote control



Télécommande_Afstandbediening_Funksteuerung mit Display_Remote control with display



Les poêles «étanches» sont complètement hermétiques par rapport à la pièce où ils sont installés et sont également appropriés pour les maisons passives modernes.

De "luchtdichte" kachels zijn hermetisch afgesloten van de ruimte waarin ze geïnstalleerd zijn en zijn ook geschikt voor moderne passieve huizen.

Raumluftunabhängige Öfen sind gegenüber der Umgebung vollständig hermetisch ausgelegt und eignen sich auch für moderne Passivhäuser.

"Airtight" stoves are room sealed and are also suitable for modern passive houses.



Idéal pour les maisons passives, caractérisées par une isolation thermique de haut niveau.

Geschikt voor passieve woningen met een grote thermische isolatie.

Geeignet für Passivhäuser mit Wärmeisolation von oberstem Niveau.

Suitable for passive houses, characterised by a high level of thermal insulation.



Système capable de gérer automatiquement la combustion du pellet.

Voor de automatische verbranding van pellets.

Für die automatische Steuerung der Pelletsverbrennung.

For automatic combustion management.

RELAX



La fonction RELAX permet de désactiver la ventilation forcée d'un seul geste, pour profiter de la chaleur à convection naturelle dans un silence absolu.

Met de RELAX-functie kan de geforceerde ventilatie met een simpele handeling worden uitgeschakeld, om in maximale stilte te genieten van de natuurlijke convectiewarmte.

Die RELAX Funktion ermöglicht das Abschalten des Warmluftgebläses mit einer einfachen Handbewegung, wenn Sie die natürliche Konvektionswärme in aller Ruhe genießen möchten.

The RELAX function allows you to deactivate the forced ventilation with one simple gesture, allowing you to enjoy the warmth of natural convection in complete silence.



Ventilation frontale air chaud désactivable

Ventilatie warme lucht vooraan uitschakelbaar

Ausschaltbares Frontal-Warmluftgebläse

Deactivatable front hot air ventilation



La fonction NIGHT permet de programmer l'extinction automatique du poêle à l'heure souhaitée, pour un confort maximal sans gaspillage de combustible. **Aujourd'hui, avec la fonction NIGHT, il est également possible de programmer l'allumage retardé, avec le poêle éteint.**

*Met de NIGHT-functie kan de automatische uitschakeling van de kachel op het gewenste tijdstip worden geprogrammeerd, voor een maximaal comfort, zonder verspilling van brandstof. **Met de NIGHT-functie is het mogelijk om ook een uitgestelde ontsteking te programmeren als de kachel uitgedoofd is.***

Die NIGHT-Funktion ist gleichwertig mit dem automatischen Ausschalten des Ofens zu einer gewissen Uhrzeit, um maximalen Komfort zu genießen und gleichzeitig keinen Brennstoff zu verschwenden. **Heute ist es dank der NIGHT-Funktion möglich, bei abgeschaltetem Ofen auch eine verzögerte Einschaltung zu programmieren.**

*The NIGHT function allows programmed, automatic switch off of the stove when you want, for utmost comfort without wasting fuel. **With stove switched off, delayed ignition can now be settled throughout the night mode as well.***



Fonction Turbo: cette fonction permet de distribuer l'air chaud à la puissance et à la vitesse maximales pour chauffer rapidement le lieu d'installation et diffuser la chaleur dans toute la pièce.

Turbofunctie: via deze functie wordt op maximaal vermogen en op maximale snelheid warme lucht geleverd om de plaats van installatie snel te verwarmen en de warmte in de hele ruimte te verspreiden.

Turbo Funktion: ermöglicht die Zufuhr der Heißluft mit maximaler Leistung und maximaler Geschwindigkeit um den Ausstellungsraum schnell zu heizen und um die Wärme in Raum schnell zu verteilen.

Turbo function: ensure hot air release at maximum power and speed, quickly heating the premises, spreading warmth throughout the room.



Le système EKleaner effectue automatiquement un double nettoyage du creuset et des turbulateurs.

Het systeem EKleaner voert automatisch een dubbele reiniging uit, van het vuurpotje en van de turbulatoren.

Das System EKleaner führt in der Brennerschale und in den Turbulatoren eine automatische Doppelreinigung aus.

The EKleaner system performs a double cleaning of the burning pot and the turbulators.



Brûleur céramique catalytique: il garantit des rendements élevés, de basses émissions et une quantité réduite de cendres, tout en limitant le nettoyage.

Katalytische keramische brander: garandeert een hoog rendement, lage uitstoot en een beperkte hoeveelheid as waardoor u minder vaak hoeft schoon te maken.

Katalytischer Keramikbrenner: garantiert einen hohen Wirkungsgrad, einen niedrigen Schadstoffausstoß und eine geringe Menge an Asche wodurch die Reinigungsarbeiten eingegrenzt werden.

Catalytic ceramic burner: ensures high efficiency, low emissions and a lower amount of ash, reducing cleaning.



Air chaud

CHAUFFER AVEC DE L'AIR UNE OU PLUSIEURS PIÈCES AU MOYEN DE CANALISATIONS.

WARME LUCHT VERWARMING MET LUCHT EEN OF MEER RUIMTES DOOR MIDDEL VAN KANALISATIES.

WARMLUFT MIT LUFT EINEN ODER MEHRERE RÄUME MITTELS WARMLUFTVERTEILUNG ERWÄRMEN.

HOT AIR HEATING IN JUST ONE OR MORE DUCTED ROOMS



Poêles à pellets Air Tight_ *Air Tight Kachels op pellets*
Air Tight Pellets-Öfen_ *Air Tight Pellet stoves* **pg. 16**



Poêle bicom bustible_ *Combikachel*
Zweifach-Brennstoff-Öfen
Dual Combustion stove **pg. 28**



Inserts à pellets *_Inbouwaarden op pellets*
Pellets-Einsätze *_Pellet inserts* **pg. 74**



Poêles à pellets *_Kachels op pellets*
Pellets-Öfen *_Pellet stoves* **pg. 30**



Foyers à bois *_Houthaarden*
Holz-Kamineinsätze *_Wood fireplaces* **pg. 94**



Foyers à pellets *_Pelletshaarden*
Pellets-Kamineinsätze *_Pellet fireplaces* **pg. 76**



Poêles à bois *_Houtkachels*
Holz-Öfen *_Wood burning stoves* **pg. 78**



Inserts à bois *_Inbouwaarden op hout*
Holz-Einsätze *_Wood inserts* **pg. 88**



AIR DIFFUSER:

chaleur et lumière réglables pour un confort sur mesure.

warmte en licht kunnen worden afgesteld, voor een comfort op maat.

regulierbare temperatur und lichtstärke für persönlichen komfort.

heat and adjustable light for made-to-measure comfort.

Pour les cheminées et les poêles à bois, Edilkamin met à disposition AIR DIFFUSER, une unité électronique gérée par radio-commande, avec laquelle il est possible de régler la ventilation de l'air chaud et l'intensité de l'éclairage, en créant une atmosphère parfaite.

AIR DIFFUSER gère jusqu'à 2 ventilateurs : chaque ventilateur peut canaliser l'air chaud jusqu'à 8 mètres maximum (avec une seule canalisation) ou bien 4 mètres (deux canalisations).

Voor vuurhaarden en kachels op hout biedt Edilkamin een AIR DIFFUSER, een elektronische regelenheid, bestuurd door afstandsbediening, waarmee de ventilatie van de warme lucht ventilatie en de intensiteit van de verlichting kan worden aangepast, en een perfecte sfeer wordt gecreëerd. AIR DIFFUSER bedient max. 2 ventilatoren: elke ventilator kan de warme lucht kanaliseren tot maximaal 8 meter (met enkele kanalisatie) of 4 meter (twee kanalisaties).

Für Herde und Öfen mit Holz als Heizmittel stellt Edilkamin den AIR DIFFUSER bereit, es handelt sich um eine elektrische Steuereinheit, die mit einer Fernbedienung bedient wird und mit der man die Ventilation der Warmluft sowie die Intensität des Lichts kontrollieren kann, wodurch eine perfekte Atmosphäre entsteht.

Der AIR DIFFUSER steuert bis zu 2 Ventilatoren: Jeder Ventilator kann Warmluft bis zu 8 Meter weit bewegen. (mit einen einzelnen Rohr) bzw. 4 Meter weit (mit zwei einzelnen Rohren).

For wood burning fireplaces and stoves, Edilkamin has made available an AIR DIFFUSER, an electronic control unit managed via remote control, allowing you to adjust hot air ventilation and lighting intensity, creating the perfect atmosphere.

AIR DIFFUSER manages up to 2 fans: each fan can duct hot air up to a maximum of 8 metres (with a single duct) or 4 metres (two ducts).

BOUCHES DESIGN: "la beauté" pour diffuser de la chaleur.

DESIGN KANALEN: "de schoonheid" van de verspreiding van warmte.

DESIGNS-ÖFFNUNGEN: Die "schöne" Seite der warmluftverteilung.

DESIGN VENTS: "beauty" distributing heat.

Les poêles, les foyers et les inserts Edilkamin peuvent distribuer de l'air chaud pour chauffer plusieurs pièces. Aujourd'hui, outre la technologie, on peut ajouter le design avec les nouvelles bouches disponibles en deux types :

- pour la circulation de l'air chaud dans la contre-hotte.
- pour diffuser de l'air chaud dans la pièce.

Edilkamin kachels en vuurhaarden kunnen hete lucht verspreiden om verschillende ruimtes te verwarmen. Vandaag de dag wordt technologie gekoppeld aan design, met nieuwe kanalen, verkrijgbaar in twee soorten:

- voor het circuleren van warme lucht in de achterwand.
- voor het verspreiden van de warme lucht in de omgeving.

Öfen, Kamineinsätze und Einsätze von Edilkamin ermöglichen die Warmluftverteilung. Heutzutage gibt es Technologien, die die Verteilung durch neue Öffnungen ermöglichen: Die Technologie entspricht heute auch dem Design; die Warmluftverteilung kann mit den neuen Öffnungen erfolgen

- Für die Zirkulation der Warmluft im Estrichunterbau.
- Für die Verteilung von Warmluft.

Edilkamin stoves, fireplaces and inserts can distribute hot air to heat multiple rooms. Today, technology meets design, with two new types of vents:

- for hot air circulation in the counter hood.
- to diffuse hot air in the room.

BOUCHES DE COMPENSATION

COMPENSATIEKANALEN_ WARMLUFT-AUSLASS_COMPENSATION VENTS

TRATTO PUNTO



LABEL



cm 60 x 7 h

cm 90 x 7 h

À placer sur la contre-hotte des cheminées. Possibilité de combiner avec les bouches pour la diffusion de l'air chaud.

Kunnen op de achterwand van de haarden geplaatst worden. Te combineren met design kanalen, voor de verspreiding van warme lucht.

Für die Positionierung auf dem Estrichunterbau des Rauchauslasses. Sind mit den Warmluftverteilungsöffnungen verbindbar.

To position on the fireplace counter hood. Can be combined with the design vents to diffuse hot air.

BOUCHES DE CANALISATION

KANALISATIE-OPENINGEN_ ÖFFNUNGEN DER WARMLUFT-VERTEILUNG_ DUCTING VENTS

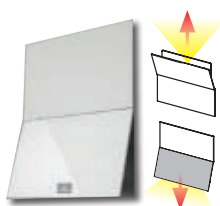

SPLIT - SPLIT V
cm 20 x 20

New

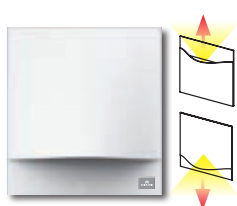

BENT - BENT V
cm 20 x 21,5 h

New

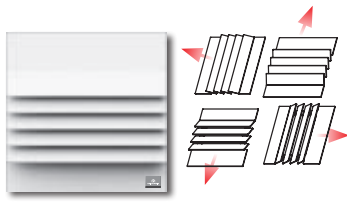

SHARP - SHARP V
cm 20 x 20

New

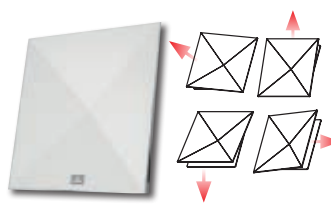

ORIGAMI - ORIGAMI V
cm 20 x 20

New



BASIC V
cm 20x20

New



Les poêles à pellets etanches (Air Tight)

Luchtdichte pelletkachels (Air Tight)

Die raumluftunabhängigen Pelletöfen (Air Tight)

Sealed pellet stoves (Air Tight)

Poêles complètement hermétiques qui prélèvent l'air à l'extérieur de la maison.

- Ils n'ont pas besoin d'une prise d'air extérieure dans la pièce d'installation.

- Ils sont idéales pour les maisons passives, mais adaptées à n'importe quelle maison.

- Ils peuvent également être installées dans la chambre à coucher (norme UNI10683, Pour l'installation et pour tout ce qui n'est pas expressément exposé, les lois nationales dans chaque pays).

Compleet luchtdichte kachels die lucht opzuigen vanaf buiten de woning.

- Er is geen externe luchtinlaat nodig in het vertrek waar de kachel wordt geïnstalleerd.

- Ideaal voor een passiefhuis, maar geschikt voor elk type woning.

- Kan ook in een slaapkamer worden geïnstalleerd (norm UNI10683, voor de installatie en voor alles wat niet uitdrukkelijk is vermeld, gelden de nationale wetten in elk land)

Vollständig dichte Öfen mit Verbrennungsluftzufuhr von außen.

- Kein Frischlufteinlass in den Installationsraum erforderlich.

- Ideal für Passivhäuser, aber auch für jeden anderen Wohnraum geeignet.

- Auch in Schlafzimmern installierbar (Norm UNI 10683, Für die Installation sind, soweit nicht anders angegeben, die im jeweiligen Land geltenden Vorschriften zu beachten).

Completely sealed stoves which take air from outside the house/apartment.

• They do not need an external air inlet in the room where they are installed.

• Perfect for passive houses, but suitable for every type of house/apartment.

• They can also be installed in bedrooms (UNI 10683 standard, For the installation, and for anything not specifically indicated in the manual, observe local regulations).

Les poêles à pellets avec sortie coaxiale supérieure (Air Tight C)

Pelletkachels met coaxiale uitlaat (Air Tight C)

Pelletöfen mit koaxialem, oberem Rauchauslass (Air Tight C)

Pellet stoves with top coaxial outlet (Air Tight C)

Le principal avantage de la sortie coaxiale réside pendant la phase d'installation, il suffit de pratiquer un seul trou comprenant la sortie des fumées et l'entrée d'air de combustion, ce qui limite les travaux en maçonnerie.

En outre, l'air de combustion est préchauffé par les fumées à la sortie, en augmentant ainsi l'efficacité du poêle.

De coaxiale uitlaat heeft als belangrijkste voordeel dat er in de installatiefase maar één opening hoeft te worden gemaakt die zowel als rookgasafvoer fungeert als als inlaat van verbrandingslucht, zodat het metselwerk wordt beperkt. Bovendien wordt de verbrandingslucht voorverwarmd door de uitgaande rookgassen, waardoor de efficiëntie van de kachel wordt verhoogd.

Hauptvorteil des koaxialen Rauchauslasses ist, dass während der Installation nur eine Bohrung vorgesehen werden muss, in der sowohl der Rauchauslass als auch der Verbrennungslufteinlass untergebracht sind, sodass die Maurerarbeiten deutlich reduziert werden.

Die Verbrennungsluft wird zudem durch den abgeführten Rauch vorgewärmt, was die Leistungsfähigkeit des Ofens noch weiter erhöht.

Coaxial outlet main advantage is that just one hole, to fit both smoke outlet and combustion air inlet, is needed on installation, thus reducing the building works amount. In this way, combustion air is also pre-heated by the outgoing smokes as well, increasing stove efficiency.

INSTALLATION AVEC TUYAU COAXIAL

INSTALLATIE MET COAXIALE BUIS

INSTALLATION MIT KOAXIALES ABGASROHR

COAXIAL PIPE INSTALLATION

Prise d'air externe

Externe luchttoevoer

Aufnahme von externer Luft

External air intake

Sortie des fumées

Rookgasafvoer

Rauchauslass

Smoke outlet

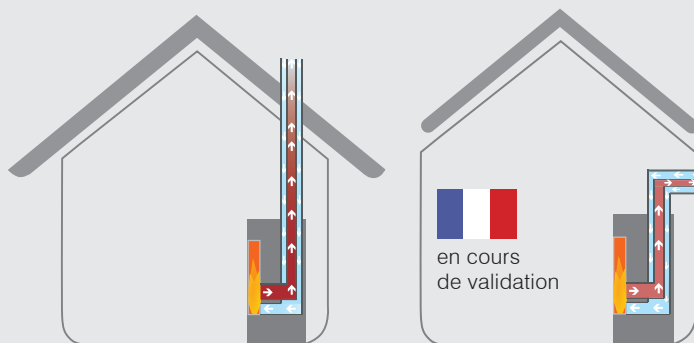

Exemple d'installation avec la sortie des fumées et la prise d'air extérieure coaxiales.

Installatievoorbeeld met coaxiale rookgasafvoer en externe luchtinlaat.

Installationsbeispiel mit Rauchauslass und koaxialem Frischlufteinlass.

Installation example with coaxial smoke outlet and external air inlet.

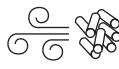

sistema
LEONARDO
LEONARDO BC
Patented

CSTB
Sous Avis Technique



New Mya Air Tight Mya Air Tight C

6,3 kW_165 m³_58x56x96 cm

LE VÉRITABLE POËLE À PELLETS ÉTANCHE
DE ECHTE LUCHTDICHTE KACHEL OP PELLETS
DER ECHTE RAUMLÜFTUNABHÄNGIGE* PELLETOFEN
THE REAL AIR TIGHT PELLET STOVE

- _ Foyer en fonte
- _ Vuurhaard in gietijzer
- _ Feuerraum aus Gusseisen
- _ Cast iron combustion chamber

*nach EN-Normenentwurf

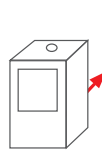

Mya AT 8Ø

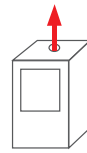

Mya ATC 8/13Ø



Verre blanc
Wit glas
Glas, weiß
White glass



Mya ATC



Verre noir
Zwart glas
Glas, schwarz
Black glass



Verre gris
Grize glas
Glas, grau
Grey glass



Acier et verre gris foncé
Donkergrijs staal en glas
Stahl und Glas, dunkelgrau
Steel and dark grey glass



Dame Air Tight

6 kW_155 m³_104x33,5xh110 cm

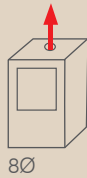

80

LE VÉRITABLE POÊLE À PELLETS ÉTANCHE
 DE ECHTE LUCHTDICHTE KACHEL OP PELLETS
 DER ECHTE RAUMLUFTUNABHÄNGIGE* PELLETOFEN
 THE REAL AIR TIGHT PELLET STOVE

_ Poêle compact avec seulement 33,5 cm
 de profondeur.
 _ Kachel met beperkte afmetingen, 33,5cm diep.
 _ Platzsparender Ofen, Tiefe 33,5 cm.
 _ 33,5 cm deep space-saving stove.

_ Foyer en Scamolex (vermiculite)
 _ Vuurhaard in Scamolex
 _ Feuerraum aus Scamolex
 _ Scamolex combustion chamber

*nach EN-Normentwurf



kit 12



12 bis

CANALISABLE_KANALISATIE
 KANALISIERBAR_DUCTABLE



** Kit Revêtements/ Kit Bekledingen
 Verkleidungs-Kit/ Coverings kit

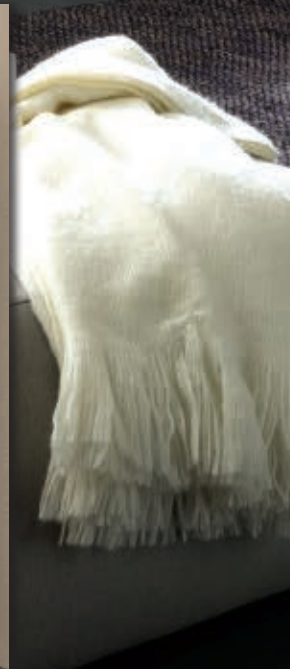

Energy:
 A++
A+
 A
 B
 C
 D
 E
 F
 G

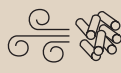

sistema
LEONARDO
Patented



CSTB
Sous Avis Technique



Acier, marbre_marmor, staa_Stahl, marbre_Steel, marble

Acier noir_Zwart staal_Schwarzer Stahl_Black steel



Ania Air Tight

8 kW_210 m³_54x54x111 cm

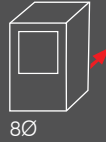

LE VÉRITABLE POÊLE À PELLETS ÉTANCHE
 DE ECHTE LUCHTDICHTE KACHEL OP PELLETS
 DER ECHTE RAUMLUFTUNABHÄNGIGE* PELLETOFEN
 THE REAL AIR TIGHT PELLET STOVE

*nach EN-Normentwurf

- _ Double fermeture réservoir
- _ Dubbele sluiting tank
- _ Doppeltes Behälterschließsystem
- _ Double closure on the hopper
- _ Foyer en fonte
- _ Gietijzeren vuurhaard
- _ Feuerraum aus Gusseisen
- _ Cast iron combustion chamber



Verre blanc_ Wit glas_ Weißes Glas_ White glass



Verre noir
 Glas zwart
 Glas schwarz
 Black glass





*sistema
LEONARDO
Patented

CSTB
Sous Avis Technique



LOU Air Tight

8 kW_210 m³_46x52xh112 cm

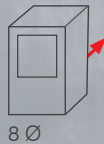

LE VÉRITABLE POÊLE À PELLETS ÉTANCHE
DE ECHTE LUCHTDICHTE KACHEL OP PELLETS
DER ECHTE RAUMLUFTUNABHÄNGIGE* PELLETOFEN
THE REAL AIR TIGHT PELLET STOVE

*nach EN-Normentwurf

- _ Foyer en Scamolex (vermiculite), en option
foyer en fonte
- _ *Vuurhaard in Scamolex, optie haard in gietijzer*
- _ Feuerraum aus Scamolex, Feuerraum aus
Gusseisen als Option
- _ *Scamolex combustion chamber, cast iron
hearth available as optional feature*



Acier gris anthracite_ *Grijs antraciet staal*
Anthrazit grau Stahl_ *Grey anthracite steel*



Double fermeture réservoir
Dubbele sluiting tank
Doppeltes Behälterschließsystem
Double closure on the hopper



Double porte de fermeture foyer
Dubbele deur afsluiting vuurhaard
Doppelte Verschlusstür für Feuerraum
Double doors on the combustion chamber



Energy

A++

A+
A
B
C
D
E
F
G



sistema
LEONARDO
PELLETS
Patented

CSTB
Sous Avis Technique



Nea Air Tight *

8 kW_210 m³_49x54x117 cm

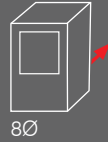

*nach EN-Normenentwurf

LE VÉRITABLE POËLE À PELLETS ÉTANCHE
DE ECHTE LUCHTDICHTE KACHEL OP PELLETS
DER ECHTE RAUMLUFTUNABHÄNGIGE* PELLETOFEN
THE REAL AIR TIGHT PELLET STOVE

- _ Foyer en Scamolex (vermiculite), en option
foyer en fonte
- _ Vuurhaard in Scamolex, optie haard in gietijzer
- _ Feuerraum aus Scamolex, Feuerraum aus
Gusseisen als Option
- _ Scamolex combustion chamber, cast iron
hearth available as optional feature

* Jusqu'à épuisement des stocks / Zolang de voorraad strekt / Solange der Vorrat reicht / While stocks last

- _ Double fermeture réservoir
- _ Dubbele sluiting tank
- _ Doppeltes Behälterschließsystem
- _ Double closure on the hopper



Verre noir_Zwart glas_Glas, schwarz_Black glass



Verre blanc_Wit glas
Glas, weiß_White glass

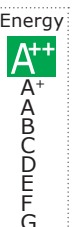

New Bild Air Tight C

9,1 kW_235 m³_80x30x110 cm

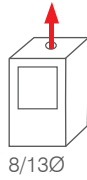

LE VÉRITABLE POÊLE À PELLETS ÉTANCHE
 DE ECHTE LUCHTDICHTE KACHEL OP PELLETS
 DER ECHTE RAUMLUFTUNABHÄNGIGE* PELLETOFEN
 THE REAL AIR TIGHT PELLET STOVE

_ Poêle compact avec seulement 30 cm de profondeur.
 _ Kachel met beperkte afmetingen, 30 cm diep.
 _ Platzsparender Ofen, Tiefe 30 cm.
 _ 30 cm deep space-saving stove.

_ Foyer en fonte
 _ Haard in staal
 _ Feuerraum aus Stahl
 _ Steel combustion chamber

_ 2 ventilateurs gérables individuellement (avec radiocomand)
 _ 2 ventilatoren die apart kunnen worden bediend (met radiobesturing)
 _ 2 individuell steuerbare Ventilatoren (mit Funkenbedienung)
 _ 2 separately-manageable fans (with remot control)



CANALISABLE_KANALISATIE
 KANALISIERBAR_DUCTABLE (kit 12-12bis)

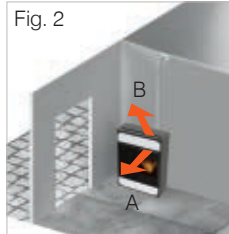
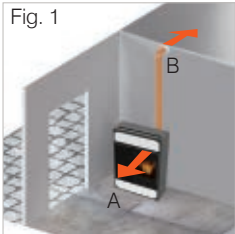

Possibilité de détourner l'air chaud canalisée(B)
 Mogelijkheid van gekanaliseerde hete lucht redirect(B)
 Möglichkeit die kanalisierte Warmluft umzulenken(B)
 Choice to divert ducted hot air (B)

*nach EN-Normentwurf



Energy
 A++
A+
 A
 B
 C
 D
 E
 F
 G

_ Céramique blanc opaque
 _ Matte witte keramiek
 _ Mattweiße Keramik
 _ Ceramic matt white

_ Céramique noire opaque
 _ Keramiek Mat zwart
 _ Matt schwarz Keramik
 _ Opaque black ceramic

_ Verre noir
 _ Zwart glas
 _ Schwarzes Glas
 _ Black glass



Pierre ollaire_Speksteen_Naturstein_Soapstone

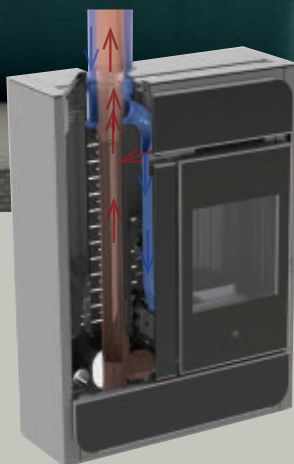

sistema
LEONARDO
Patented

CSTB
Sous Avis Technique



Vyda Air Tight

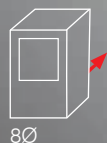

C ramique blanc opaque
Matte witte keramiek
Mattwei er Keramik
Ceramic matt white



_ Top coulissant pour le chargement du pellets
_ Uitschuifbaar bovenblad voor het laden van de pellets
_ Verschiebbares Oberteil f ur die Pelletseinf ullung
_ Sliding top for feeding pellet

New Vyda Air Tight C

10 kW_260 m³_55x55x106 cm

LE VÉRITABLE POËLE À PELLETS ÉTANCHE
 DE ECHTE LUCHTDICHTE KACHEL OP PELLETS
 DER ECHTE RAUMLUFTUNABHÄNGIGE* PELLETOFEN
 THE REAL AIR TIGHT PELLET STOVE

- _ Foyer en fonte
- _ Vuurhaard in gietijzer
- _ Feuerraum aus Gusseisen
- _ Cast iron combustion chamber

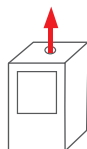
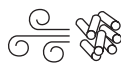

8/130



Pierre ollaire
 Speksteen
 Speckstein
 Soapstone



Pag. 16



Céramique gris foncé
 Donkergrijze keramiek
 Dunkelgrauer Keramik
 Ceramic dark grey



Pierre ollaire_Speksteen_Naturstein_Soapstone





sistema
LEONARDO
Patented



e-Brusher
Patented

Demy

10 kW_260 m³_107x45,5x105 cm (pellet)

10,9 kW_285 m³_107x45,5x105 cm

POÊLE BICOMBUSTIBLE (pellet, bois)
COMBIKACHEL (pellet, hout)
ZWEIFACH-BRENNSTOFF-OFEN (pellet, holz)
DUAL COMBUSTION STOVE (pellet, wood)

Foyer en chamotte
Vuurhaard in vuurvast materiaal
Feuerraum aus Schamotte
Combustion chamber in refractory material



Ce système, absolument innovant et «Breveté Edilkamin», exploite la double action de la vis d'alimentation des pellets. La haute performance de ce système consent une autonomie même de quelques mois sans nécessité d'interventions manuelles de nettoyage du creuset.

Het betreft een absoluut innovatief systeem, "gepatenteerd door Edilkamin", dat gebruik maakt van een dubbele werking van de schroef voor het aanvoeren van de pellets. Het systeem presteert zo voortreffelijk dat het een autonomie mogelijk maakt, zelfs van maanden, zonder manuele tussenkomst voor het reinigen van het haardonderstel.

Es handelt sich hierbei um ein absolut innovatives und von "Edilkamin patentiertes" System, das die doppelte Wirkung der Pellet-Beschickungsschnecke ausnutzt. Das System ist so leistungsstark, dass auch eine monatelange Autonomie möglich ist, ohne manuelle Eingriffe zur Tiegelreinigung.

This is a highly innovative system, patented by Edilkamin, which employs a double action of the pellet-loading screw. The high-performance system allows autonomous use for months at a time, without the need for manual chamber cleaning.

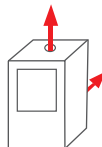

150



* Verre sérigraphié blanc_ Wit gla_Glas mit Siebdruck, Weiß_ White printed glass



* Jusqu'à épuisement des stocks / Zolang de voorraad strekt / Solange der Vorrat reicht / While stocks last

* Verre sérigraphié gris
Grijs glas
Glas mit Siebdruck, Grau
Grey printed glass



Jane*

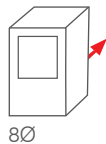

4,9 kW_130 m³_46x49xh92 cm

POÊLES À PELLETS
KACHELS OP PELLETS
PELLETSÖFEN
PELLET STOVES

_ Foyer en fonte
_ Vuurhaard in gietijzer
_ Feuerraum aus Gusseisen
_ Cast iron combustion chamber



* Jusqu'à épuisement des stocks / Zolang de voorraad strekt / Solange der Vorrat reicht / While stocks last



Céramique parchemin
Perkament keramiek
Pergamentfarben Keramik
Parchment ceramic



Céramique bordeaux
Keramiek bordeaux
Keramik bordeaux
Bordeaux ceramic



Céramique noire
Zwart keramiek
Keramik schwarz
Black ceramic

Energy
A⁺⁺
A⁺
A
B
C
D
E
F
G



Céramique blanc opaque_Mat wit keramiek
Mattweiß Keramik_White ceramic

Slide/ Slide7

4,9 kW_130 m³_46x49xh99,5/100/101

• 7,1 kW_185 m³_46x49xh99,5/100/101

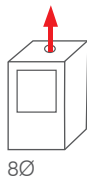

POÊLES À PELLETS
KACHELS OP PELLETS
PELLETSÖFEN
PELLET STOVES

_ Foyer en fonte
_ Vuurhaard in gietijzer
_ Feuerraum aus Gusseisen
_ Cast iron combustion chamber

_ Sortie des fumées vers le haut
_ Rookgasafvoer bovenaan
_ Rauchauslass oben
_ Smoke outlet upper



_ Top coulissant pour le chargement du pellets
_ Uitschuifbaar bovenblad voor het laden van de pellets
_ Verschiebbares Oberteil für die Pelletseinfüllung
_ Sliding top for feeding pellet



• Acier noir
Zwart staal
Schwarzer Stahl
Black steel



• Marbre blanc de Carrare
Carrara marmor
Weißer Carrara-Marmor
White Carrara marble



Marbre rose du Portugal
Rosa Portugallo marmor
Rosafarbiger portugiesischer Marmor
Red Portuguese marble



Marbre Botticino vieillii
Botticino antico marmor
Botticino mit Antike-Effekt
Antique Botticino marble

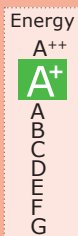



sistema
LEONARDO
LEONARDO
Patented



• Pierre ollaire_ *Speksteen*
Naturstein_ *Soapstone*



Verre noir
Zwart glas
Schwarzem Glas
Black glass



Verre blanc
Wit glas
Weißes Glas
White glass

Marbres différents disponible à la demande.
Verschillende marmersoorten verkrijgbaar op aanvraag.
Andere Marmersorten sind auf Anfrage verfügbar.
Other marble available on request.

Lille

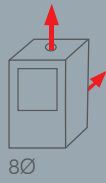

5 kW_130 m³_64x58x80 cm

8,1 kW_210 m³_64x58x80 cm

POÊLES À PELLETS
KACHELS OP PELLETS
PELLETSÖFEN
PELLET STOVES

- _ COMPLÈTEMENT en fonte
avec foyer en fonte
Hele structuur en vuurhaard in gietijzer
- _ GESAMTE STRUKTUR und Feuerraum
aus Gusseisen
- _ *STRUCTURE and combustion
chamber ENTIRELY in cast iron*
- _ Possibilité de supprimer les pieds
Mogelijkheid om de voetjes te elimineren
- _ Abnehmbare Stützfüße
Option to remove feet





Fonte noir bouchardé *Zwart gegolfd gietijzer*
Gusseisen schwarz mit Riffelung Embossed black cast iron

Mya Eco

6,3 kW_165 m³_58x56xh96 cm

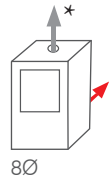

POÊLES À PELLETS
KACHELS OP PELLETS
PELLETSÖFEN
PELLET STOVES

N'est pas disponible
pour le marché français

- _Foyer en fonte
- _Vuurhaard in gietijzer
- _Feuerraum aus Gusseisen
- _Cast iron combustion chamber



*
_vers le haut, en option _kit couvre-conduit en option
_bovenaan, optioneel _kit voor schoorste
_enpijbedekking optioneel
_Rauchauslass oben Optional _Kit Rohrhülse Optional
_output from the top optional _flue cover kit optional



Verre noir
Zwart glas
Glas, schwarz
Black glass

Verre gris
Grize glas
Glas, grau
Grey glass

Verre blanc
Wit glas
Glas, weiß
White glass



Acier et verre gris foncé
Donkergrijs staal en glas
Stahl und Glas, dunkelgrau
Steel and dark grey glass

Pierre ollaire_Speksteen_Naturstein_Soapstone



Aris Up

8 kW_210 m³_53x55x97 cm

POÊLES À PELLETS
KACHELS OP PELLETS
PELLETSÖFEN
PELLET STOVES

_Foyer en fonte
_Vuurhaard in gietijzer
_Feuerraum Gusseisen
_Cast iron combustion chamber

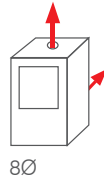

Aris Up Plus

8 kW_210 m³_53x55x97 cm

POÊLES À PELLETS CANALISABLE
KACHEL OP PELLETS KANALISATIE
PELLETSÖFEN KANALISIERBAR
DUCTABLE PELLET STOVE



Acier et céramique gris_ Staal en Grijs keramiek
Stahl und Grau Keramik_ Steel and Grey ceramic



kit 12 - 12 bis_ Aris Up Plus

CANALISABLE_ KANALISATIE
KANALISIERBAR_ DUCTABLE

Acier_ Staal_ Stahl_ Steel



Céramique blanc crème
Roomwit keramiek
Cremeweiß Keramik
Cream white ceramic



Céramique parchemin
Perkament keramiek
Keramik pergamentfarben
Parchment ceramic



Céramique bordeaux
Bordeaux keramiek
Bordeaux Keramik
Bordeaux ceramic



Aris Up

8 kW_210 m³_53x55xh97 cm

POÊLES À PELLETS
KACHELS OP PELLETS
PELLETSÖFEN
PELLET STOVES

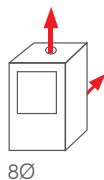

8Ø

Aris Up Plus

8 kW_210 m³_53x55xh97 cm

POÊLES À PELLETS CANALISABLE
KACHEL OP PELLETS KANALISATIE
PELLETSÖFEN KANALISIERBAR
DUCTABLE PELLET STOVE

- _ Foyer en fonte
- _ Vuurhaard in gietijzer
- _ Feuerraum Gusseisen
- _ Cast iron combustion chamber
- _ ventilateurs gérables individuellement
(avec radiocomand)
- _ ventilatoren die apart kunnen worden bediend
(met radiobesturing)
- _ individuell steuerbare Ventilatoren (mit Funkenbedienung)
- _ separately-manageable fans (with remot control)



kit 12 - 12 bis_Aris Up Plus

CANALISABLE_KANALISATIE
KANALISIERBAR_DUCTABLE



Céramique bordeaux
Bordeaux keramiek
Keramik bordeaux
Bordeaux ceramic



Céramique gris
Keramiek grijs
Keramik grau
Grey ceramic



Céramique parchemin
Keramiek perkament
Keramik pergamentfarben
Parchment ceramic





C ramique blanc cr me_ *Keramiek roomwit*
Keramik cremewei _ *Cream white ceramic*

Kikka*

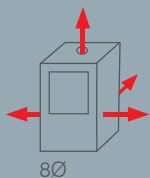

8 kW_210 m³_43x51xh93 cm

POÊLES À PELLETS
KACHELS OP PELLETS
PELLETSÖFEN
PELLET STOVES

_ Foyer en fonte et acier
_ Haard in staal en gietijzer
_ Feuerraum aus Gusseisen und Stahl
_ Cast iron and steel combustion chamber

* Jusqu'à épuisement des stocks / Zolang de voorraad strekt / Solange der Vorrat reicht / While stocks last





option
optioneel
Option
optional



Acier noir et verre sérigraphié noir
Staal met geserigrafeerd zwart glas
Stahl und Glas mit schwarzem Siebdruck
Black steel and black silkscreen-printed glass.

New Klik

8,3 kW_215 m³_47x49,5x100 cm

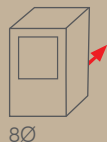

POÊLES À PELLETS
KACHELS OP PELLETS
PELLETSÖFEN
PELLET STOVES

- _ Structure et foyer en fonte
- _ Structuur en vuurhaard in gietijzer
- _ Struktur und Feuerraum aus Gusseisen
- _ Cast iron structure and combustion chamber



2 boutons:

- _ allumage/extinction; puissances
- _ allumage retardée programmable

2 voyants lumineux:

- _ Voyant réserve pellet
- _ nettoyage du creuset

2 knoppen:

- _ ontsteken/uitdoven; vermogens
- _ programmeerbare vertraagde ontsteking

2 waarschuwingen met verlichting:

- _ Controlelampje pelletreserve
- _ reiniging van het vuurpotje

2 Regelknöpfe:

- _ Einschaltung/Ausschaltung; Leistungen
- _ programmierbare verzögerte Einschaltung

2 Leuchtanzeigen:

- _ Pellet-Reserveanzeige
- _ Reinigung der Brennerschale.

2 knobs:

- _ switching ON/OFF; power rates
- _ programmable delayed switching ON

2 warning lights:

- _ pellet reserve indicator
- _ burning pot cleaning.



Céramique grise foncé
Donkergrijze keramiek
Dunkelgrauer Keramik
Dark grey ceramic





sistema
LEONARDO
LEUVEN
Patented



option
optioneel
Option
optional



C ramique blanc opaque
Matte witte keramiek
Mattwei er Keramik
Opaque white ceramic



...to Cup
...in Bucher
...book
...veshark
...e
nostalgia

New
Klik



New Evia

8,2 kW_215 m³_56x57xh113 cm

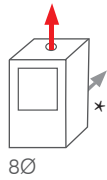

POÊLES À PELLETS
KACHEL OP PELLETS
PELLETSÖFEN
PELLET STOVE

_ Structure et foyer en fonte
_ Structuur en vuurhaard in gietijzer
_ Struktur und Feuerraum aus Gusseisen
_ Cast iron structure and combustion chamber

*
_ vers l'arrière, en option
_ achteraan, Optionele
_ hinten, Option
_ rear, Optional



Double porte
Dubbele deur
Doppeltür
Double door



Acier bronze
Brons staal
Bronzefarbener Stahl
Bronze steel



Acier noir
Zwart staal
Schwarzer Stahl
Black steel





Acier blanc opaque
Mat wit staal
Mattweiße Stahl
Opaque white steel



Acier bronz
Bronz staal
Bronzefarbener Stahl
Bronze steel

New Evia





New

- _ Verre noir
- _ Zwart glas
- _ Schwarzes Glas
- _ Black glass

New Bild

9,1 kW_235 m³_80x30xh110 cm

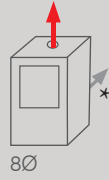

POÊLES À PELLETS
KACHELS OP PELLETS
PELLETSÖFEN
PELLET STOVES

_ Foyer en fonte
_ Vuurhaard in gietijzer
_ Feuerraum aus Gusseisen
_ Cast iron combustion chamber

_ ventilateurs gérables individuellement
(avec radiocomand)
_ ventilatoren die apart kunnen worden bediend
(met radiobesturing)
_ individuell steuerbare Ventilatoren
(mit Funkenbedienung)
_ separately-manageable fans
(with remot control)

*
_ vers l'arrière, en option
_ achteraan, Optionele
_ hinten, Option
_ rear, Optional



_ Céramique blanc opaque
_ Matte witte keramiek
_ Mattweiße Keramik
_ Ceramic matt white

Fig. 1

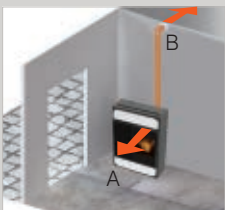
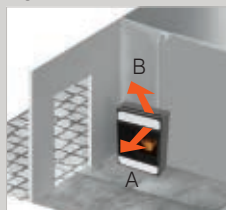

Fig. 2



Possibilité de détourner l'air chaud canalisée (B)
Mogelijkheid van gekanaliseerde hete lucht redirect (B)
Möglichkeit die kanalisierte Warmluft umzulenken (B)
Choice to divert ducted hot air (B)



_ Céramique noire opaque
_ Keramiek Mat zwart
_ Matt schwarz Keramik
_ Opaque black ceramic



_ Pierre ollaire
_ Speksteen
_ Naturstein
_ Soapstone



Logo

9,1 kW_235 m³_62x56x103 cm

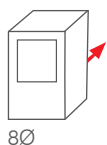

POÊLES À PELLETS
KACHELS OP PELLETS
PELLETSÖFEN
PELLET STOVES

- _ Structure totalement en fonte
- _ Geheel gietijzeren structuur
- _ Struktur vollständig aus Gusseisen
- _ Structure entirely made of cast iron



Energy
A++
A+
A
B
C
D
E
F
G

C ramique bordeaux
Keramik bordeaux
Keramik bordeaux
Bordeaux ceramic

C ramique blanc cr me
Wit cr mekleur keramik
Keramik altwei 
Cream ceramic



C ramique grise_Keramik grijs
Keramik grau_Grey ceramic

C ramique Noir_Keramik Zwart
Schwarze Keramik_Black ceramic



C ramique bleu p trole
Keramik petroleumgroene
Roh lfarbiger Keramik
Petroleum blue ceramic



C ramique Blanc opaque
Keramik Mat wit
Mattwei e Keramik
Opaque ceramic white

Nara

7,1 kW_185 m³_46x49xh99 cm

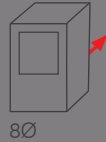

POÊLES À PELLETS
KACHELS OP PELLETS
PELLETSÖFEN
PELLET STOVES

_ Foyer en fonte
_ Vuurhaard in gietijzer
_ Feuerraum aus Gusseisen
_ Cast iron combustion chamber

Nara Plus

9 kW_235 m³_46x49xh99 cm

POÊLES À PELLETS CANALISABLE
KACHEL OP PELLETS KANALISATIE
PELLETSÖFEN KANALISIERBAR
DUCTABLE PELLET STOVE

_ ventilateurs gérables individuellement
(avec radiocomand)
_ ventilatoren die apart kunnen worden bediend
(met radiobesturing)
_ individuell steuerbare Ventilatoren
(mit Funkenbedienung)
_ separately-manageable fans
(with remot control)



Céramique bordeaux_ Bordeaux keramiek
_ Bordeaux Keramik_ Bordeaux ceramic

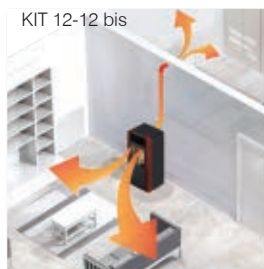

CANALISABLE_ KANALISATIE
KANALISIERBAR_ DUCTABLE

Adaptateur de 6 à 8 cm de diamètre
Adapter van Ø 6 tot 8 cm
Adapter von Ø 6 auf 8 cm
Adaptor from Ø 6 to 8 cm
(KIT12/12 bis)



C ramique bordeaux
Keramik bordeaux
Keramik bordeaux
Bordeaux ceramic

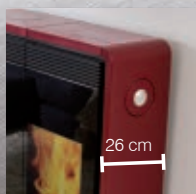

C ramique blanc opaque _Mat wit keramik
Mattwei  Keramik _White ceramic opaque

Tiny

9 kW_235 m³_90x26xh121 cm

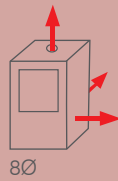

POÊLE À PELLETS "GAIN DE PLACE"
KACHEL OP PELLETS SLECHTS 26CM DIEP.
PELLETSÖFEN, DAS "MINIMALE" RAUMWUNDER
(NUR 26 CM TIEFE).
SPACE-SAVING PELLET STOVE, JUST 26 CM DEEP.

- _ Foyer en fonte
- _ Vuurhaard in gietijzer
- _ Feuerraum Gusseisen
- _ Cast iron combustion chamber



Céramique noire
Zwart keramiek
Keramik schwarz
Black ceramic

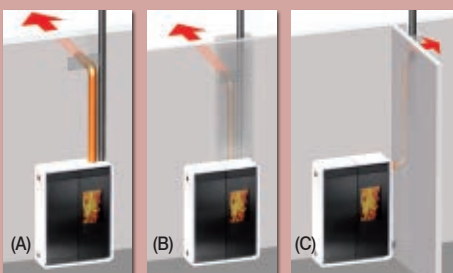

_ Alternatives pour sortie de fumée et conduits d'air chaud par le top (A) par l'arrière (B) par le côté (C)

_ Verschillende mogelijkheden voor de rookgasafvoer en warmluchtkanalen op de bovenkant (A) aan de achterkant (B) aan de zijkant (C)

_ Alternativen für Rauchauslass und Warmluftauslass Von der Oberseite (A) Von der Rückseite (B) Von der Seite (C)

_ Alternatives for smoke outlet and warm air channels from the top (A) the rear (B) the side (C).

Cherie Up

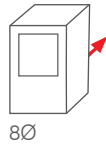

11,2 kW_290 m³_62x57xh115 cm

POÊLES À PELLETS CANALISABLE
KACHEL OP PELLETS KANALISATIE
PELLETSÖFEN KANALISIERBAR
DUCTABLE PELLET STOVE

- _ Structure et foyer en fonte
 - _ Structuur en vuurhaard in gietijzer
 - _ Struktur und Feuerraum aus Gusseisen
 - _ Cast iron structure and combustion chamber
-
- _ ventilateurs gérables individuellement (avec radiocomand)
 - _ ventilatoren die apart kunnen worden bediend (met radiobesturing)
 - _ individuell steuerbare Ventilatoren (mit Funkenbedienung)
 - _ separately-manageable fans (with remot control)



CANALISABLE_KANALISATIE
KANALISIERBÄR_DUCTABLE kit 12 - 12 bis
Adaptateur de 8 à 6 cm de diamètre
Adapter van Ø 8 tot 6 cm
Adapter von Ø 8 auf 6 cm
Adaptor from Ø 8 to 6 cm
(Split, Bent, Origami, Sharp pg.14)

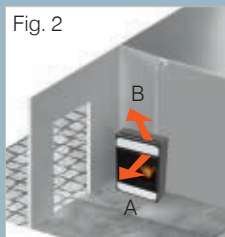
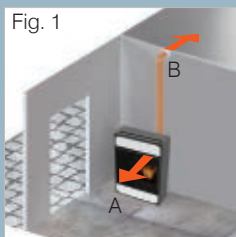

Possibilité de détourner l'air chaud canalisée(B)
Mogelijkheid van gekanaliseerde hete lucht redirect(B)
Möglichkeit die kanalisierte Warmluft umzulenken(B)
Choice to divert ducted hot air (B)



Verre blanc
Wit glas
Glas, weiß
White glass



Verre noir
Zwart glas
Glas, schwarz
Black glass



Céramique blanc crème_Roomwit keramiek
 Cremeweiß Keramik_Cream white ceramic



Céramique bordeaux
 Keramiek bordeaux
 Keramik bordeaux
 Bordeaux ceramic



Céramique gris foncé
 Donkergrijs keramiek
 Dunkelgraue Keramik
 Dark grey ceramic



Céramique poivre et sel
 Keramiek peper en zout
 Keramik mit Salz-und-Pfeffer-Optik
 Salt and pepper ceramic

Cherie Up

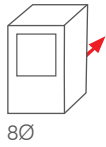

11,2 kW_290 m³_62x57xh115 cm

POÊLES À PELLETS CANALISABLE
KACHEL OP PELLETS KANALISATIE
PELLETSÖFEN KANALISIERBAR
DUCTABLE PELLET STOVE

- _ Structure et foyer en fonte
- _ Structuur en vuurhaard in gietijzer
- _ Struktur und Feuerraum aus Gusseisen
- _ Cast iron structure and combustion chamber

- _ ventilateurs gérables individuellement (avec radiocomand)
- _ ventilatoren die apart kunnen worden bediend (met radiobesturing)
- _ individuell steuerbare Ventilatoren (mit Funkenbedienung)
- _ separately-manageable fans (with remot control)



CANALISABLE_KANALISATIE
KANALISIERBÄR_DUCTABLE kit 12 - 12 bis
Adaptateur de 8 à 6 cm de diamètre
Adapter van Ø 8 tot 6 cm
Adapter von Ø 8 auf 6 cm
Adaptor from Ø 8 to 6 cm
(Split, Bent, Origami, Sharp pg.14)

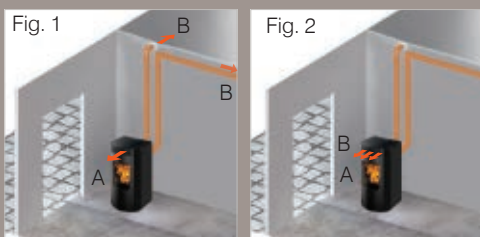

Possibilité de détourner l'air chaud canalisée(B)
Mogelijkheid van gekanaliseerde hete lucht redirect(B)
Möglichkeit die kanalisierte Warmluft umzulenken(B)
Choice to divert ducted hot air (B)



Pierre ollaire
Speksteen
Naturstein
Soapstone



Acier bronze *Brons staal*
 Bronzefarbener Stahl *Bronze steel*



Acier gris foncé
Donkergrijs stalen
 Dunkelgraue Stahl
Dark grey steel



Acier blanc opaque
Mat wit staal
 Mattweiße Stahl
Opaque white steel



Acier bordeaux
Bordeaux staal
 Bordeaux-Stahl
Bordeaux steel



Acer et céramique grise_ *Staal en keramiek grijs*
 Stahl und grauer Keramik_ *Steel and grey ceramic*



Acer et céramique blanc crème
Staal en roomwit keramiek
 Stahl und Keramik cremeweiß
Steel and cream white ceramic



Acer et céramique bordeaux
Staal en bordeaux keramiek
 Stahl und bordeaux Keramik
Steel and bordeaux ceramic

Sally

12 kW_315 m³_57x62xh111 cm

POÊLES À PELLETS
KACHELS OP PELLETS
PELLETSÖFEN
PELLET STOVES

Pré-équipement pour la canalisation
Montagemogelijkheid kanalisatie
Vorbereitung für Kanalisierung
Set up for ductwork

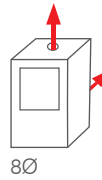

Sally Plus

12 kW_315 m³_57x62xh111 cm

POÊLES À PELLETS CANALISABLE
KACHEL OP PELLETS KANALISATIE
PELLETSÖFEN KANALISIERBAR
DUCTABLE PELLET STOVE

_Foyer en fonte et acier
_Haard in staal en gietijzer
_Feuerraum aus Gusseisen und Stahl
_Cast iron and steel combustion chamber



Céramique blanc crème_Keramiëk roomwit
Keramik cremeweiß_Cream white ceramic



Céramique bordeaux
Keramiëk bordeaux
Keramik bordeaux
Bordeaux ceramic



Céramique parchemin
Keramiëk perkament
Keramik pergamentfarben
Parchment ceramic



kit 11 - 11 bis_Sally plus
CANALISABLE_KANALISATIE
KANALISIERBAR_DUCTABLE



Pierre ollaire_Speksteen_Naturstein_Soapstone



CANALISABLE
KANALISATIE
KANALISIERBAR
DUCTABLE

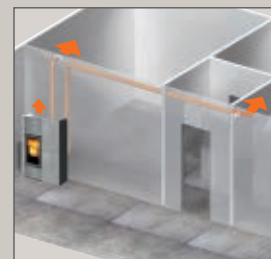

Avec le kit 3ème ventilateur
accessoire en option
Met kit 3e ventilator optioneel
Mit Bausatz für den 3. Lüfter (Option)
With optional 3rd fan kit

Blade

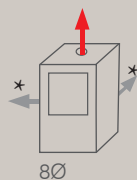

12,1 kW_315 m³_90x34,5xh113 cm

POÊLE À PELLETS "GAIN DE PLACE"
 KACHEL OP PELLETS SLECHTS 34,5CM DIEP.
 PELLETSÖFEN, DAS "MINIMALE" RAUMWUNDER
 (NUR 34,5 CM TIEFE).
 SPACE-SAVING PELLET STOVE, JUST 34,5 CM DEEP.

- _ Foyer en fonte
- _ Vuurhaard in gietijzer
- _ Feuerraum aus Gusseisen
- _ Cast iron combustion chamber

- *
 _ vers l'arrière ou latérale gauche, en option
 _ achteraan of aan de zijkant links Optionele
 _ hinten oder seitlich links Option
 _ rear and left side Optional

- _ ventilateurs gérables individuellement (avec radiocomand)
 _ ventilatoren die apart kunnen worden bediend
 (met radiobesturing)
 _ individuell steuerbare Ventilatoren (mit Funkenbedienung)
 _ separately-manageable fans (with remot control)



Acier blanc opaque_Mat wit staal
 Mattweiß Stahl_Opaque white steel



Acier noir
 Zwart staal
 Schwarzer Stahl
 Black steel



Acier bronze
 Brons staal
 Bronzefarbener Stahl
 Bronze steel



Acier bordeaux
 Bordeaux staal
 Bordeaux-Stahl
 Bordeaux steel



Blade

12,1 kW_315 m³_98x34,5xh113 cm

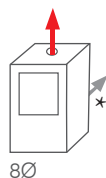

POÊLE À PELLETS "GAIN DE PLACE"
 KACHEL OP PELLETS SLECHTS 34,5CM DIEP.
 DAS "MINIMALE" RAUMWUNDER
 (NUR 34,5 CM TIEFE). PELLETSÖFEN
 SPACE-SAVING PELLET STOVE, JUST 34,5 CM DEEP.

- _ Foyer en fonte
- _ Vuurhaard in gietijzer
- _ Feuerraum aus Gusseisen
- _ Cast iron combustion chamber

- _ ventilateurs gérables individuellement (avec radiocomand)
- _ ventilatoren die apart kunnen worden bediend (met radiobesturing)
- _ individuell steuerbare Ventilatoren (mit Funkenbedienung)
- _ separately-manageable fans (with remot control)



*
 à l'arrière en option
 achteraan Optionele
 hinten Option
 rear Optional

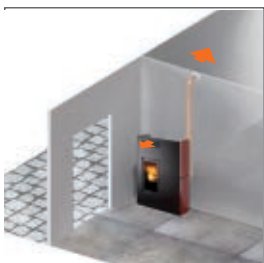

CANALISABLE
 KANALISATIE
 KANALISIERBAR
 DUCTABLE

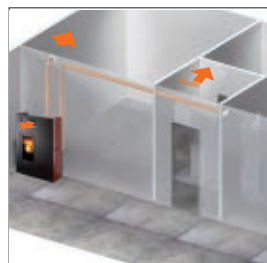

Avec le kit 3ème ventilateur
 accessoire en option
 Met kit 3e ventilator optioneel
 Mit Bausatz für den 3. Lüfter (Option)
 With optional 3rd fan kit



Céramique blanc opaque
 Mat wit keramiek
 Mattweiße Keramik
 Opaque white ceramic



Céramique bordeaux
 Keramiek bordeaux
 Keramik bordeaux
 Bordeaux ceramic



Céramique beige
 Beige keramiek
 Beige Keramik
 Beige ceramic





C ramique noir brillant_ *Glanzend zwart keramiek*
Gl nzende schwarze Keramik_ *Glossy black ceramic*



Pierre ollaire_Speksteen
Speckstein_Soapstone

Energy
A++
A+
A
B
C
D
E
F
G



Vyda

14,3 kW_375 m³_62,5x61,5x121,5 cm

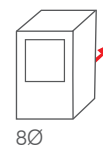

POÊLES À PELLETS CANALISABLE
 KACHEL OP PELLETS KANALISATIE
 PELLETSÖFEN KANALISIERBAR
 DUCTABLE PELLET STOVE

_ Foyer en fonte
 _ Vuurhaard in gietijzer
 _ Feuerraum aus Gusseisen
 _ Cast iron combustion chamber

_ ventilateurs gérables individuellement (avec radiocomand)
 _ ventilatoren die apart kunnen worden bediend
 (met radiobesturing)
 _ individuell steuerbare Ventilatoren (mit Funkenbedienung)
 _ separately-manageable fans (with remot control)



CANALISABLE_KANALISATIE
 KANALISIERBAR_DUCTABLE (kit 12-12bis)

Adaptateur de 8 à 6 cm de diamètre
 Adapter van Ø 8 tot 6 cm
 Adapter von Ø 8 auf 6 cm
 Adaptor from Ø 8 to 6 cm
 (Split, Bent, Origami, Sharp pag.14)

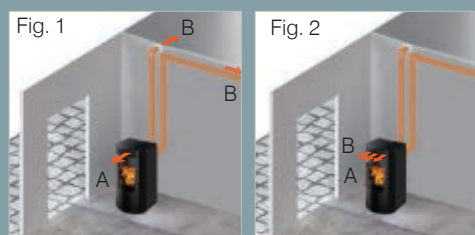

Possibilité de détourner l'air chaud canalisée(B)
 Mogelijkheid van gekanaliseerde hete lucht redirect(B)
 Möglichkeit die kanalisierte Warmluft umzulenken(B)
 Choice to divert ducted hot air (B)



Céramique blanc opaque
 Matte witte keramiek
 Mattweißer Keramik
 Matt white ceramic



Céramique gris foncé
 Donkergrijze keramiek
 Dunkelgrauer Keramik
 Dark grey ceramic

Kira

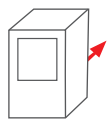

8Ø

14,3 kW_375 m³_65x63xh123,5 cm

POÊLES À PELLETS CANALISABLE
KACHEL OP PELLETS KANALISATIE
PELLETSÖFEN KANALISIERBAR
DUCTABLE PELLET STOVE

_ Foyer en fonte
_ Vuurhaard in gietijzer
_ Feuerraum aus Gusseisen
_ Cast iron combustion chamber

_ ventilateurs gérables individuellement (avec radiocomand)
_ ventilatoren die apart kunnen worden bediend
(met radiobesturing)
_ individuell steuerbare Ventilatoren (mit Funkenbedienung)
_ separately-manageable fans (with remot control)



kit 12 - 12 bis
CANALISABLE_KANALISATIE
KANALISIERBAR_DUCTABLE
Adaptateur de 8 à 6 cm de diamètre
Adapter van Ø 8 tot 6 cm
Adapter von Ø 8 auf 6 cm
Adaptor from Ø 8 to 6 cm
(Split, Bent, Origami, Sharp pag.14)

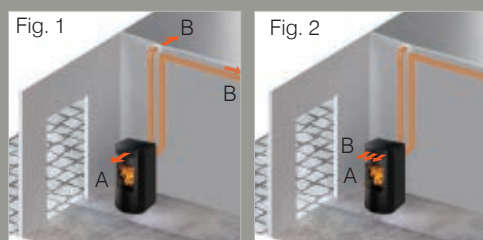

Possibilité de détourner l'air chaud canalisée (B)
Mogelijkheid van gekanaliseerde hete lucht redirect (B)
Möglichkeit die kanalisierte Warmluft umzulenken (B)
Choice to divert ducted hot air (B)



Céramique bordeaux
Keramiëk bordeaux
Keramik bordeaux
Bordeaux ceramic



Céramique parchemin
Keramiëk pergament
Keramik pergamentfarben
Parchment ceramic



C ramique blanc cr me_Roomwit keramik
Cremewei  Keramik_Cream white ceramic

Pellkamin 8

INSERTS À PELLETS
INBOUWAARDEN OP PELLETS
PELLETS-EINSÄTZE
PELLET INSERTS

_ Foyer en fonte
_ Vuurhaard in gietijzer
_ Feuerraum Gusseisen
_ Cast iron combustion chamber



Pellkamin 10

INSERTS À PELLETS
INBOUWAARDEN OP PELLETS
PELLETS-EINSÄTZE
PELLET INSERTS

_ Foyer en fonte
_ Vuurhaard in gietijzer
_ Feuerraum Gusseisen
_ Cast iron combustion chamber



Energy
A++
A+
A
B
C
D
E
F
G

8,1 kW 210 m³ 74x46x49 cm

REVÊTEMENTS_BEKLEDINGEN
VERKLEIDUNGËN_COVERINGS
Air, Arabesque, High Tech, Incas, Iron,
Sahara, Silver

Energy
A++
A+
A
B
C
D
E
F
G

10,4 kW 270 m³ 74x46x49 cm

REVÊTEMENTS_BEKLEDINGEN
VERKLEIDUNGËN_COVERINGS
Air, Arabesque, High Tech, Incas, Iron, Sahara,
Silver

avec insert ÉTEINT / met inbouwhaard UITGESCHAKELD
bei AUSGESCHALTETEM Einsatz / with insert OFF

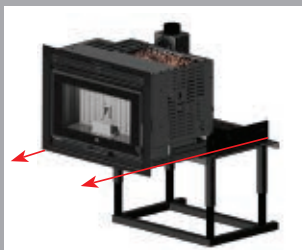

A.
Chargement des granulés par extraction de l'insert sur des glissières.
Bijvullen pellets door het inzetframe op geleiders uit te trekken.
Beladung der Pellets durch Herausziehen des Einsatzes auf Schienen.
Extraction insert pellet loading on runners.

avec insert EN FONCTION / met inbouwhaard AANGESCHAKELD
bei EINGESCHALTETEM Einsatz / with insert ON



B.
Chargement à l'aide du tiroir frontale (en option).
Bijvullen via de lade voor frontaal bijvullen (optie).
Beladung mit vorderer Schublade (Option).
Loading with frontal load tray (optional).





avec insert EN FONCTION / *met inbouwhaard AANGESCHAKELD*
 bei EINGESCHALTETEM Einsatz / *with insert ON*



C.
 Chargement avec la trappe par
 le haut (en option).
Bijvullen via het bijvulluik (optie).
 Beladung durch Einfüllstutzen
 (Option).
Trapdoor loading (optional).

Pellkamin12

12,1 kW_315 m³

FOYERS À PELLETS
HAARDEN OP PELLETS
PELLETS-KAMINEINSÄTZE
PELLET FIREPLACES

_ Foyer en fonte
_ Vuurhaard in gietijzer
_ Feuerraum Gusseisen
_ Cast iron combustion chamber

RELAX



_ Ventilation air chaud désactivable
_ Ventilatie warme lucht uitschakelbaar
_ Ausschaltbares Warmluftgebläse
_ Deactivatable hot air ventilation



A.

_ 93x60,5xh58 cm

*
_ chargement par la trappe,
_ bijvullen via luik
_ Pellet-Einfüllrutsche
_ hatch loading



C.

_ 93x63xh79 cm



B.

_ 93x63xh75 cm

**
_ chargement avec tiroir
_ bijvullen met lade,
_ Pellet-Einfüllschublade,
_ tray loading



D.

_ 93x63xh87 cm

Canalisable _kanalisatie
Kanalierbar _Ductable

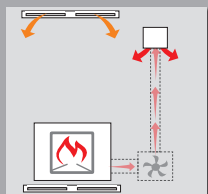

A.B.
Installation avec_ Installatie met_ Installation mit_ installation with Kit AIR DIFFUSER
2xØ6 cm
_ 2 bouches LABEL, kit de ventilation et cadre, ventilation déportée
_ 2 vulopeningen LABEL, ventilatiekit en omlijsting, gekanaliseerde ventilatie
_ 2 LABEL Luftdurchlässe, Ventilator-Teilesatz und Rahmen, Warmluftkanalisierung
_ 2 LABEL vents, ventilation kit and frame, ducted ventilation

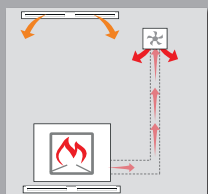

Installation avec BOUCHES VENTILÉES_ Installatie met geventileerde UITBLAASOPENINGEN
Installation mit WARMLUFTAUSLÄSSE MIT VENTILATOR_ installation with VENTILATED AIR VENTS
2xØ10 cm
_ 2 bouches LABEL, cadre d'encadrement
_ 2 vulopeningen LABEL en omlijsting
_ 2 LABEL Luftdurchlässe und Rahmen
_ 2 LABEL vents and frame

C. D.
_ air en façade et cadre, ventilation intégrée
_ lucht frontaal en omlijsting, geïntegreerde ventilatie
_ frontseitiges Ausblasgitter und Rahmen,
_ integriertes Warmluftgebläse
_ front air and frame, built-in ventilation





Pierre ollaire
 Speksteen
 Naturstein
 Soapstone



Acier gris
 Grijs stalen
 Grauer Stahl
 Grey steel

Acier noir
 Zwart staal
 Schwarzer Stahl
 Black steel

Acier bronzé
 Brons staal
 Bronzefarbener Stahl
 Bronze steel

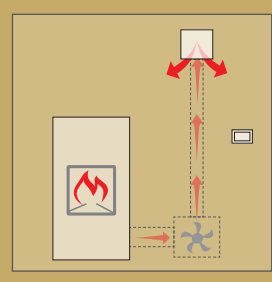

AIR DIFFUSER
 Tally, Tally Up

Tally

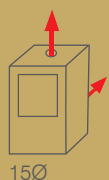

6,6 kW _170 m³ _50x50xh128 cm
h131cm (pierre ollaire, *speksteen*, Naturstein, *soapstone*)

POÊLES À BOIS
HOUTKACHELS
HOLZOFEN
WOOD BURNING STOVES

_Foyer en Scamolex (vermiculite), en option foyer en fonte
_Vuurhaard in Scamolex, optie haard in gietijzer
_Feuerraum aus Scamolex, Feuerraum aus Gusseisen als Option
_Scamolex combustion chamber, cast iron hearth available as optional feature

Tally Up

_vitre rond
_ronde glazen
_rundes Glas
_round glass

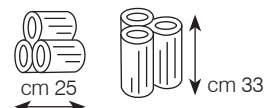
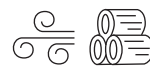

Acier bronzé
Brons staal
Bronzefarbener Stahl
Bronze steel

_Kit allumage automatique, option
_Set automatische ontsteking, optioneel
_Kit automatisches Einschalten, Option
_Automatic switch on kit, optional

_Kit tiroir pour le rangement du bois
_Set zwart stalen houtlade
_Kit stahlschwarzes Holzgehäuse
_Black steel wooden drawer kit

Tally (en option, *optioneel*, Option, *optional*)
Tally Up



Acier gris
Grijs stalen
Grauer Stahl
Grey steel



Acier noir
Zwart staal
Schwarzer Stahl
Black steel



Pierre ollaire
Speksteen
Naturstein
Soapstone





Acier noir *_Zwart staal*
 Schwarzer Stahl *_Black steel*



Acier gris
Grijs stalen
 Grauer Stahl
 Grey steel



Pierre ollaire
Speksteen
 Naturstein
 Soapstone



Acier bronzé
Bronz staal
 Bronzefarbener Stahl
 Bronze steel



Kit tiroir pour le rangement du bois
Set zwart stalen houtlade

Kit stahlschwarzes Holzgehäuse
Black steel wooden drawer kit

Tally Up S

Tally S (en option, *optioneel*, Option, *optional*)

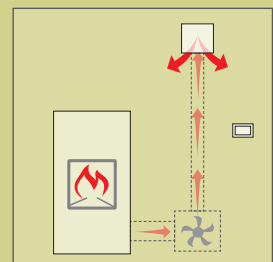

AIR DIFFUSER
 Tally S, Tally Up S

Tally S

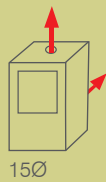

6,6 kW _ 170 m³ _ 50x50xh176 cm
h179 cm (pierre ollaire, *speksteen*, Naturstein, *soapstone*)

POÊLES À BOIS
HOUTKACHELS
HOLZOFEN
WOOD BURNING STOVES

- _ Foyer en Scamolex (vermiculite), en option foyer en fonte
- _ Vuurhaard in Scamolex, optie haard in gietijzer
- _ Feuerraum aus Scamolex, Feuerraum aus Gusseisen als Option
- _ Scamolex combustion chamber, cast iron hearth available as optional feature
- _ Kit allumage automatique, option
- _ Set automatische ontsteking, optioneel
- _ Kit automatisches Einschalten, Option
- _ Automatic switch on kit, optional

Prédisposés pour le kit de pierre réfractaire (en option)

La partie supérieure avec des anneaux réfractaires permet d'accumuler de la chaleur et de la libérer de manière prolongée pour réchauffer la maison, y compris dans les heures suivant le dernier chargement de bois.

Si l'on charge le bois le soir, le matin on trouve les braises prêtes pour un allumage rapide.

Bestemd voor accumulatie (optioneel)

In de bovenkant met vuurvaste ringen kan de warmte worden opgeslagen en worden afgegeven, om uw huis te verwarmen, ook in de uren na de laatste Houtlading. Belading 's avonds en 's morgens met gloeiend houtskool voor een nieuwe verlichting.

Ausgestattet für Speicher (Option)

Der obere Teil mit hitzebeständigen Ringen macht die Ansammlung von Hitze für längere Zeit möglich, um das Haus auch in den Stunden nach der letzten Beladung mit Holz zu erwärmen.

Beladen Sie den Ofen am Abend und am Morgen finden Sie Kohlen bereit für eine neue Zündung.

Prepared for accumulation (kit optional)

The top with refractory rings allows prolonged heat accumulation to heat the house, even for hours after the last wood was loaded. load at night and a new switch switches on in the morning.

40 kg



Partie supérieure avec anneaux réfractaires. (en option)

Top met vuurvaste ringen (optioneel)

Oberer Teil mit hitzebeständigen Ringen. (Option)

Top with refractory rings. (kit optional)



Tally Up S

- _ vitre rond
- _ ronde glazen
- _ rundes Glas
- _ round glass

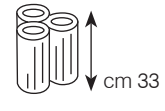

Pierre ollaire_ *Speksteen*
Naturstein_ *Soapstone*



Acier gris
Grijs stalen
Grauer Stahl
Grey steel



Acier noir
Zwart staal
Schwarzer Stahl
Black steel



Acier bronzé
Bronz staal
Bronzefarbener Stahl
Bronze steel



Fiord

8 kW_210 m³_47x41,5xh133,5 cm

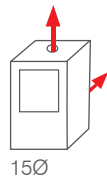

POÊLE À BOIS
HOUTKACHEL
HOLZOFEN
WOOD BURNING STOVE

- _ Foyer en Scamolex (vermiculite), en option foyer en fonte
- _ Vuurhaard in Scamolex, optie haard in gietijzer
- _ Feuerraum aus Scamolex, Feuerraum aus Gusseisen als Option
- _ Scamolex combustion chamber, cast iron hearth available as optional feature
- _ Kit allumage automatique, option
- _ Set automatische ontsteking, optioneel
- _ Kit automatisches Einschalten, Option
- _ Automatic switch on kit, optional

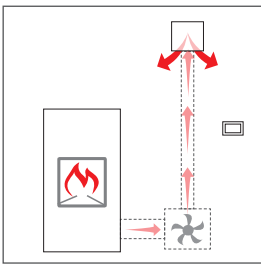
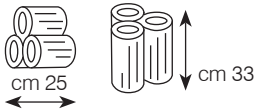

AIR DIFFUSER



Energy
A++
A+
A
B
C
D
E
F
G

Acier noir et pierre ollaire
Zwart staal en speksteen
Schwarzer Stahl und Naturstein
Black steel and soapstone





Acier noir_Zwart staal
Schwarzer Stahl_Black steel

Lilia/L *

6,6 kW_170 m³_60x48x94 cm

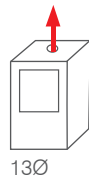

POÊLES À BOIS
HOUTKACHELS
HOLZOFEN
WOOD BURNING STOVES

_ Foyer en fonte
_ Vuurhaard in gietijzer
_ Feuerraum aus Gusseisen
_ Cast iron combustion chamber

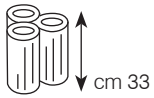

* Jusqu'à épuisement des stocks / Zolang de voorraad strekt / Solange der Vorrat reicht / While stocks last



Céramique bordeaux
Bordeauxkleurige keramiek
Keramik bordeaux
Bordeaux ceramic



C ramique cr me _ Cr mekleurige keramiek _ Keramik elfenbeinfarbe _ Cream ceramic

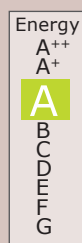
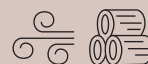

Big



c ramique blanc cr me
keramiek wit cr mekleur
Keramik altwei 
cream ceramic



c ramique parchemin
perkament keramiek
Pergament Keramik
parchment ceramic



c ramique bordeaux
keramiek bordeaux
Keramik bordeaux
bordeaux ceramic

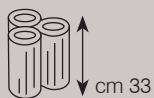

cm 33

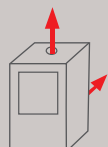

15Ø

Vip

11,5 kW_300 m³_68x53xh115cm

POÊLES À BOIS CANALISABLE
HOUTKACHELS KANALISATIE
HOLZOFEN KANALISIERBAR
DUCTABLE WOOD BURNING STOVES

_Foyer en Ecokeram
_Vuurhaard in Ecokeram
_Feuerraum aus Ecokeram
_Ecokeram combustion chamber



_Céramique bordeaux_Keramik bordeaux
_Keramik bordeaux_Bordeaux ceramic

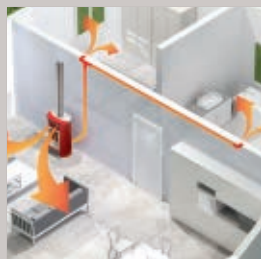

kit 8 OPTIONAL
CANALISABLE_KANALISATIE
KANALISIERBAR_DUCTABLE



Céramique blanc crème
Keramik wit crèmekleur
Keramik altweiß
Cream ceramic



Céramique parchemin
Perkament keramik
Pergament Keramik
Parchment ceramic



New Inwood 70/49 70/55

9 kW_235 m³_69x45xh49/55 cm

INSERTS À BOIS
INBOUWAARDEN OP HOUT
HOLZ-EINSÄTZE
WOOD INSERTS

_Vitre en façade
_Glas voorzijde
_Frontseitige Glasscheibe
_Front glass



Energy
A++
A+
A
B
C
D
E
F
G

Nouvelle gamme de design pour rénover les anciennes cheminées ou en réaliser de nouvelles.

Nieuwe designs om oude haarden te renoveren of nieuwe haarden te realiseren.

Neue Design Produktpalette zur Erneuerung bestehender Kamine oder um neue zu Bauen.

New design range to renovate old fireplaces or to create new ones.

_Foyer au choix:
Chamotte - Scamolex (vermiculite)

_Vuurhaard naar keuze:
Vuurvast materiaal - Scamolex (vermiculite)

_Wählbare Feuerräume:
Feuerfestes Material -Scamolex (vermiculite)

_Choice of combustion chambers:
Refractory -Scamolex (vermiculite)



_Régulateur de la ventilation forcée (V)
_Regeleenheid van geforceerde ventilatie (V)
_Kontrolleinheit des Warmluftgebläse (V)
_Forced ventilation control unit (V)





New Inwood2 70/49
70/55

9 kW_235 m³_70x51xh49/55 cm

INSERTS À BOIS
INBOUWAARDEN OP HOUT
HOLZ-EINSÄTZE
WOOD INSERTS

_Vitre latérale gauche/droite
_Glas linkerzijde/rechterzijde
_Links-/rechtsseitige Glasscheibe
_Left/right side glass



Energy
A++
A+
A
B
C
D
E
F
G



New Inwood3 70/55

9 kW_235 m³_72x51xh55 cm

INSERTS À BOIS
INBOUWAARDEN OP HOUT
HOLZ-EINSÄTZE
WOOD INSERTS

_Vitre à trois faces
_Driezijdig glas
_Dreiseitige Verglasung
_Three-sided glass



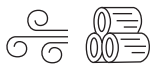

Luce Plus 54/62

INSERTS À BOIS
INBOUWAARDEN OP HOUT
HOLZ-EINSÄTZE
WOOD INSERTS



Energy
A++
A+
A
B
C
D
E
F
G

54 9 kW_235 m³_65x45xh61 cm

62 10,7 kW_280 m³_70x50xh68 cm

- _ Foyer en fonte
- _ Vuurhaard in gietijzer
- _ Feuerraum aus Gusseisen
- _ Cast iron combustion chamber

REVÊTEMENTS _BEKLEDINGEN
VERKLEIDUNGEN _COVERINGS
Air, Arabesque, Bix Box 62, High Tech, Incas, Iron,
Sahara, Silver, Wood



KIT 1-2-3
CANALISABLE _KANALISATIE
KANALISIERBÄR _DUCTABLE

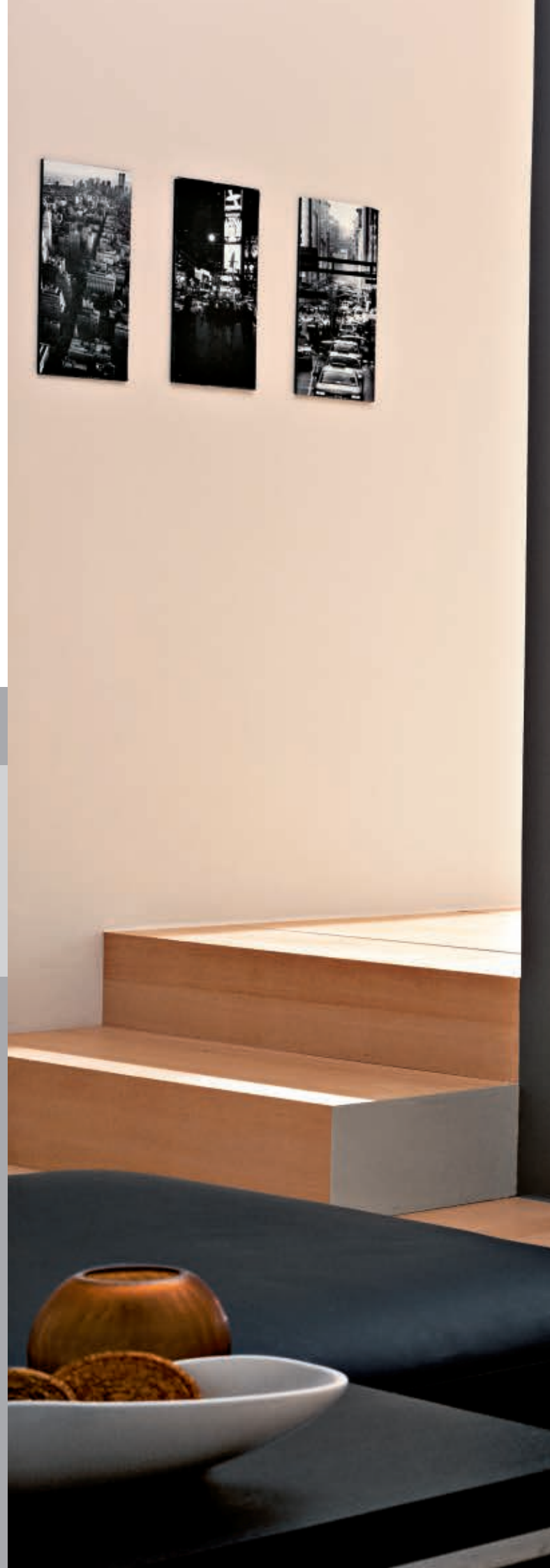



revêtement_bekledingen_Verkleidungen_covering
Arabesque (Luce Plus 54/62)

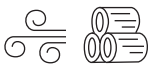

Windo3 85

FOYERS À BOIS
HOUTHARDEN
HOLZ-KAMINEINSÄTZE
WOOD FIREPLACES



Windo3 P50

FOYERS À BOIS
HOUTHARDEN
HOLZ-KAMINEINSÄTZE
WOOD FIREPLACES



85

13,2 kW_345 m³_92x63xh150 cm

- _ Foyer en chamotte
- _ Vuurhaard in vuurvast materiaal
- _ Feuerraum aus Schamotte
- _ Combustion chamber in refractory



12 kW_315 m³_58x92xh150 cm

- _ Foyer en chamotte
- _ Vuurhaard in vuurvast materiaal
- _ Feuerraum aus Schamotte
- _ Combustion chamber in refractory



KIT 1 BIS - 4 BIS - 5 BIS
CANALISABLE_KANALISATIE
KANALISIERBAR_DUCTABLE

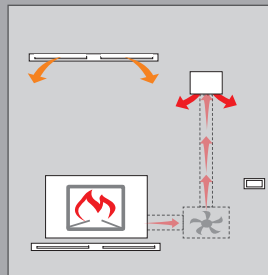

AIR DIFFUSER

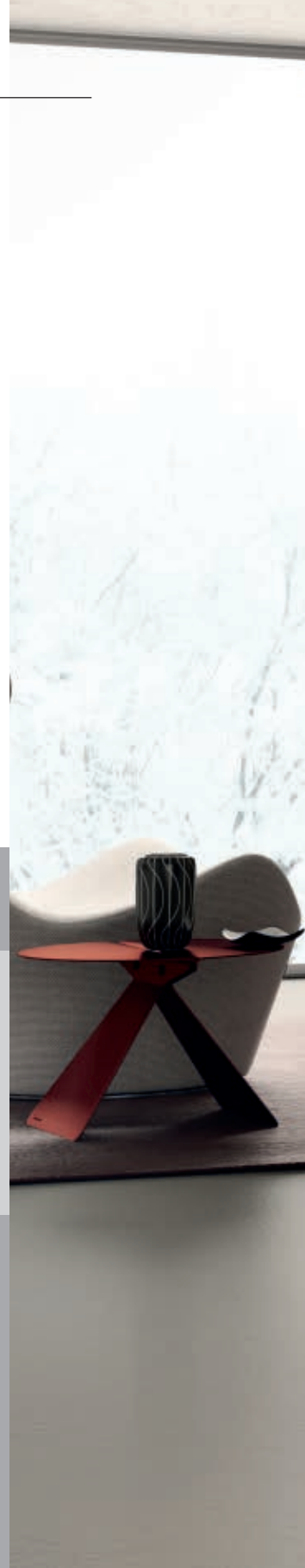



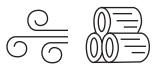

Windo2 75

FOYERS À BOIS
HOUTHAARDEN
HOLZ-KAMINEINSÄTZE
WOOD FIREPLACES

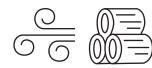

Windo2 95

FOYERS À BOIS
HOUTHAARDEN
HOLZ-KAMINEINSÄTZE
WOOD FIREPLACES



75 L/R

13,2 kW_345 m³_94x63xh150 cm

- _ Foyer en chamotte
- _ Vuurhaard in vuurvast materiaal
- _ Feuerraum aus Schamotte
- _ Combustion chamber in refractory

95 L/R

14,7 kW_385 m³_114x63xh150 cm



KIT 1 BIS - 4 BIS - 5 BIS
CANALISABLE_KANALISATIE
KANALISIERBAR_DUCTABLE

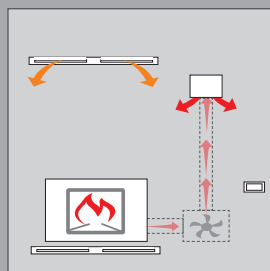

AIR DIFFUSER



revêtement *bekledingen* Verkleidungen
covering - Life (Windo2, 75/95)

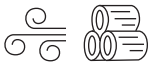

Side Plus 50x50

FOYERS À BOIS
HOUTHAARDEN
HOLZ-KAMINEINSÄTZE
WOOD FIREPLACES



12,4 kW_325 m³_60x60xh148 cm

- _ Foyer en chamotte
- _ Vuurhaard in vuurvast materiaal
- _ Feuerraum aus Schamotte
- _ Combustion chamber in refractory

REVÊTEMENTS_BEKLEDINGEN
VERKLEIDUNGEN_COVERINGS
Nice, Sweet



KIT 6 BIS
CANALISABLE_KANALISATIE
KANALISIERBÄR_DUCTABLE





revêtement_bekledingen_Verkleidungen_covering
Sweet (Side plus 50x50)



Cristal 45

FOYERS À BOIS
HOETHAARDEN
HOLZ-KAMINEINSÄTZE
WOOD FIREPLACES



13 kW_340 m³_68x64xh161 cm

_ Foyer en Ecokeram
_ Vuurhaard in Ecokeram
_ Feuerraum aus Ecokeram
_ Combustion chamber in Ecokeram

REVÊTEMENTS_BEKLEDINGEN
VERKLEIDUNGËN_COVERINGS
Bix Box, Dromond

V
Kit ventilation pour transformer en ventilation forcée/
Ventilatiekit om de versie met natuurlijke convection om te vormen tot een versie met gedwongen ventilatie
Lüftungs-Kit zum Umbau von natürlicher Luftführung (N) zu Gebläselüftung (V)/ *Ventilation kit to convert version N into forced ventilation*



KIT 1 BIS - 2 BIS - 3 BIS (CRISTAL45, CRISTAL76)
KIT 4 BIS - 5 BIS (CRISTAL 90)

CANALISABLE_KANALISATIE
KANALISIERBÄR_DUCTABLE

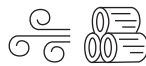

Cristal 76

FOYERS À BOIS
HOETHAARDEN
HOLZ-KAMINEINSÄTZE
WOOD FIREPLACES



15 kW_390 m³_98x65xh147 cm

_ Foyer en Ecokeram
_ Vuurhaard in Ecokeram
_ Feuerraum aus Ecokeram
_ Combustion chamber in Ecokeram

REVÊTEMENTS_BEKLEDINGEN
VERKLEIDUNGËN_COVERINGS
Air, Bix Box, Dromond, Iron, Silver

V
Kit ventilation pour transformer en ventilation forcée/
Ventilatiekit om de versie met natuurlijke convection om te vormen tot een versie met gedwongen ventilatie
Lüftungs-Kit zum Umbau von natürlicher Luftführung (N) zu Gebläselüftung (V)/ *Ventilation kit to convert version N into forced ventilation*

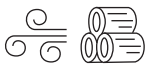

Cristal 90

FOYERS À BOIS
HOUTHAARDEN
HOLZ-KAMINEINSÄTZE
WOOD FIREPLACES



Energy
A++
A+
A
B
C
D
E
F
G

20,1 kW_525 m³_112x65xh168 cm

- _ Foyer en Ecokeram
- _ Vuurhaard in Ecokeram
- _ Feuerraum aus Ecokeram
- _ Combustion chamber in Ecokeram

REVÊTEMENTS _BEKLEDINGEN_ VERKLEIDUNGEN_
COVERINGS

Bix Box, Dromond

V

Kit ventilation pour transformer en ventilation forcée/
*Ventilatiekit om de versie met natuurlijke convectorie om
te vormen tot een versie met gedwongen ventilatie!*
Lüftungs-Kit zum Umbau von natürlicher Luftführung (N)
zu Gebläselüftung (V)/ *Ventilation kit to convert version N
into forced ventilation*



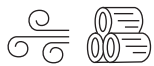

Flat 100

FOYERS À BOIS
HOUTHAARDEN
HOLZ-KAMINEINSÄTZE
WOOD FIREPLACES



Energy
A++
A+
A
B
C
D
E
F
G

12 kW_315 m³_125/165x59xh134 cm

- _ Foyer en Ecokeram
- _ Vuurhaard in Ecokeram
- _ Feuerraum aus Ecokeram
- _ Combustion chamber in Ecokeram

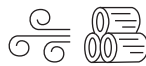

Flat 120

FOYERS À BOIS
HOUTHAARDEN
HOLZ-KAMINEINSÄTZE
WOOD FIREPLACES



Energy
A++
A+
A
B
C
D
E
F
G

14 kW_365 m³_143/183x59xh134 cm

- _ Foyer en Ecokeram
- _ Vuurhaard in Ecokeram
- _ Feuerraum aus Ecokeram
- _ Combustion chamber in Ecokeram

REVÊTEMENTS_ BEKLEDINGEN_ VERKLEIDUNGEN_ COVERINGS

Bix Box 100, Iron, Sahara 100, Silver

V
Kit ventilation pour transformer en ventilation forcée/
Ventilatiekit om de versie met natuurlijke convectorie om te vormen tot een versie met gedwongen ventilatie
Lüftungs-Kit zum Umbau von natürlicher Luftführung (N) zu Gebläselüftung (V)/ *Ventilation kit to convert version N into forced ventilation*



KIT 1 BIS - 2 BIS - 3 BIS - 4 BIS - 5 BIS

CANALISABLE_ KANALISATIE
KANALISIERBÄR_ DUCTABLE

V
Kit ventilation pour transformer en ventilation forcée/
Ventilatiekit om de versie met natuurlijke convectorie om te vormen tot een versie met gedwongen ventilatie
Lüftungs-Kit zum Umbau von natürlicher Luftführung (N) zu Gebläselüftung (V)/ *Ventilation kit to convert version N into forced ventilation*

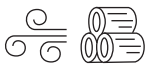

Double

FOYERS À BOIS
HOUTHAARDEN
HOLZ-KAMINEINSÄTZE
WOOD FIREPLACES



Energy
A⁺⁺
A⁺
A
B
C
D
E
F
G

12 kW_315 m³_98x67xh147 cm

_Foyer en Ecokeram
_Vuurhaard in Ecokeram
_Feuerraum aus Ecokeram
_Combustion chamber in Ecokeram

REVÊTEMENTS_BEKLEDINGEN_VERKLEIDUNGEN_
COVERINGS
Air, Bix Box, Iron, Silver



KIT 1 BIS - 2 BIS - 3 BIS

CANALISABLE_KANALISATIE
KANALISIERBÄR_DUCTABLE



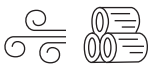

Screen Evo 80/100

FOYERS À BOIS
HOUTHAARDEN
HOLZ-KAMINEINSÄTZE
WOOD FIREPLACES

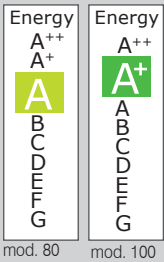

80 13 kW_340 m³_93x53xh75 cm
100 14,6 kW_380 m³_113x53xh75 cm

- _ Foyer en chamotte
- _ Vuurhaard in vuurvast materiaal
- _ Feuerraum aus Schamotte
- _ Combustion chamber in refractory

mod. 80 mod. 100

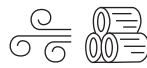

Screen Up 80/100

FOYERS À BOIS
HOUTHAARDEN
HOLZ-KAMINEINSÄTZE
WOOD FIREPLACES

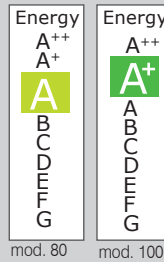

80 13 kW_340 m³_93x53xh75 cm
100 14,6 kW_380 m³_113x53xh75 cm

- _ Foyer en chamotte
- _ Vuurhaard in vuurvast materiaal
- _ Feuerraum aus Schamotte
- _ Combustion chamber in refractory

mod. 80 mod. 100

Chevalet réglable en hauteur
In hoogte verstelbare steun
Gestell zur Einstellung der Höhe
Height adjustable stand

Ouverture latérale (lors de l'assemblage, elle peut être installée avec l'ouverture de la porte à gauche ou à droite).

Opening aan zijkant (kan tijdens de montagefase geïnstalleerd worden met deuropening naar links of rechts).

Seitliche Öffnung (Einbau bei der Aufstellung des Geräts für Türanschlag rechts oder links).

Side opening (during installation, this can be installed with the door opening either to the right or left).



KIT 1 BIS - 2 BIS - 3 BIS
CANALISABLE
KANALISATIE
KANALISIERBAR
DUCTABLE

Vision agréable de la flamme
Nouvelle ouverture de la porte rabattable
Chevalet réglable en hauteur

Mooi uitzicht op de vlam
Nieuwe klepdeur
In hoogte verstelbare steun

Angenehme Sicht auf die Flamme
Neuartige Klappenöffnung
Gestell zur Einstellung der Höhe

Pleasant view of flame
New flip-up opening
Height adjustable stand

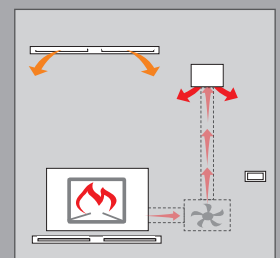

AIR DIFFUSER



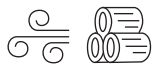

Forte Plus

FOYERS À BOIS
HOUTHAARDEN
HOLZ-KAMINEINSÄTZE
WOOD FIREPLACES



Energy **A** 19 kW_495 m³_98x60xh160 cm



- _ Foyer en fonte
- _ Vuurhaard in gietijzer
- _ Feuerraum Gusseisen
- _ Cast iron combustion chamber

REVÊTEMENTS_BEKLEDINGEN_VERKLEIDUNGEN_
COVERINGS

Air, Bix Box, Dromond, Iron, Mexico, Sahara, Silver

V
Kit ventilation pour transformer en ventilation forcée/
Ventilatiekit om de versie met natuurlijke convectie om
te vormen tot een versie met gedwongen ventilatie/
Lüftungs-Kit zum Umbau von natürlicher Luftführung
(N) zu Gebläselüftung (V)/ *Ventilation kit to convert
version N into forced ventilation*



KIT 1 BIS - 2 BIS - 3 BIS - 4 BIS - 5 BIS

CANALISABLE_KANALISATIE
KANALISIERBÄR_DUCTABLE

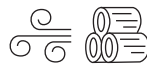

Status Plus

FOYERS À BOIS
HOUTHAARDEN
HOLZ-KAMINEINSÄTZE
WOOD FIREPLACES



Energy **A** 16 kW_415 m³_95x60xh160 cm



- _ Foyer en fonte
- _ Vuurhaard in gietijzer
- _ Feuerraum Gusseisen
- _ Cast iron combustion chamber

REVÊTEMENTS_BEKLEDINGEN_VERKLEIDUNGEN_
COVERINGS

-

V
Kit ventilation pour transformer en ventilation forcée/
Ventilatiekit om de versie met natuurlijke convectie
om te vormen tot een versie met gedwongen
ventilatie/ Lüftungs-Kit zum Umbau von natürlicher
Luftführung (N) zu Gebläselüftung (V)/ *Ventilation kit
to convert version N into forced ventilation*



KIT 1 BIS - 2 BIS - 3 BIS - 4 BIS - 5 BIS

CANALISABLE_KANALISATIE
KANALISIERBÄR_DUCTABLE

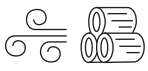

Titano Plus

FOYERS À BOIS
HOUTHAARDEN
HOLZ-KAMINEINSÄTZE
WOOD FIREPLACES



Energy
A++
A+
A
B
C
D
E
F
G

18,5 kW_480 m³_96x60xh160 cm

- _ Foyer en fonte
- _ Vuurhaard in gietijzer
- _ Feuerraum Gusseisen
- _ Cast iron combustion chamber

REVÊTEMENTS_BEKLEDINGEN_VERKLEIDUNGEN_COVERINGS

V
Kit ventilation pour transformer en ventilation forcée/
Ventilatiekit om de versie met natuurlijke convectorie om te vormen tot een versie met gedwongen ventilatie!
Lüftungs-Kit zum Umbau von natürlicher Luftführung (N) zu Gebläselüftung (V)/ *Ventilation kit to convert version N into forced ventilation*



KIT 1 BIS - 2 BIS - 3 BIS - 4 BIS - 5 BIS

CANALISABLE_KANALISATIE
KANALISIERBÄR_DUCTABLE





Eau chaude

CHAUFFER CHAUFFER AVEC DE L'EAU TOUTE LA MAISON.

WARM WATER
VERWARMING MET WATER DOOR HET
HELE HUIS.

WARMES WASSER
MIT WASSER DAS GANZE HAUS
ERWÄRMEN.

HOT WATER
HEATING WITH WATER ALL THE HOUSE.

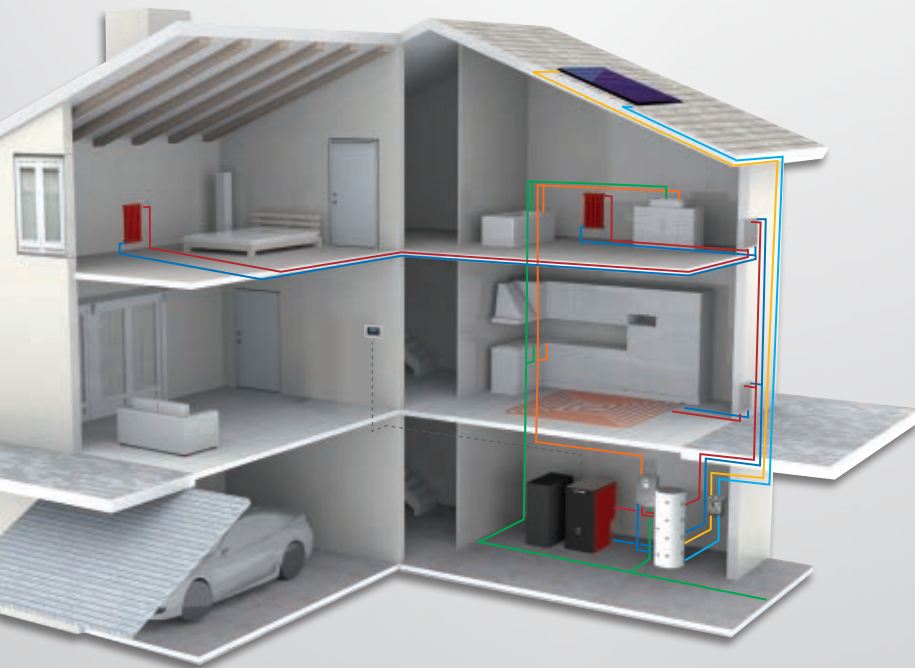

Thermopoêles à pellets *Thermokachels op pellets*_ Wassergeführte Pellets-Öfen *Pellet thermo-stoves* **pg. 112**



Chaudières multi combustibles
Multi brandstof Ketels
Mehrstoff-Heizkessel
Multi-fuel burning boiler **pg. 139**



Thermopoêles à bois *houtthermokachels*
Wassergeführte Holz-Öfen *Wood thermo-stoves* **pg.142**



Thermocheminées à pellets *Thermohaarden op pellets*
Wassergeführte Pellets-Kamineinsätze
Pellet thermo-fireplaces **pg.134**



Chaudières à pellets
PelletsKetels
Pellets-Heizkessel
Pellet boilers **pg. 138**



Thermocheminées à bois *Houtthermohaarden*
Wassergeführte Holz-Kamineinsätze
Wood thermo-fireplaces **pg.148**



Chaudières à bois
HoutKetels
Holz-Heizkessel
Wood boilers **pg. 140**



Revêtements *Bekledingen*
Verkleidungen *Coverings* **pg. 154**



CHOISISSEZ L'INNOVATION du double nettoyage automatique.
 KIES DE INNOVATIE VAN de automatische dubbele reiniging.
 ENTSCHEIDEN SIE SICH FÜR die Innovation Der automatischen Doppelreinigung.
 CHOOSE THE INNOVATIVE, automatic double cleaning system.

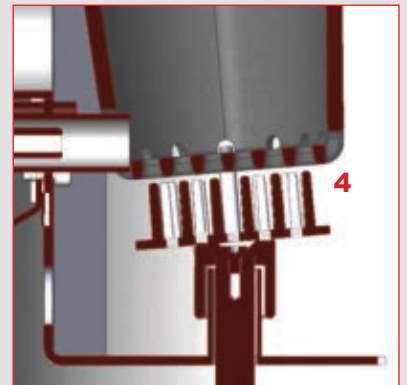
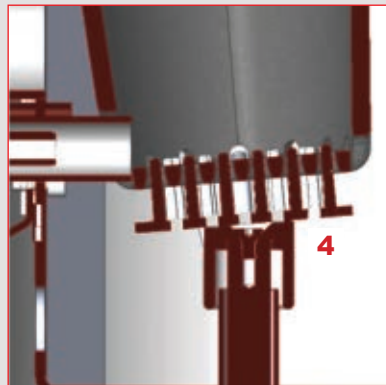

Le motoréducteur (1) actionne automatiquement la barre placée sous le creuset (2).

La barre, à son tour, déplace les turbulateurs qui nettoient les tuyaux des fumées (3) et actionne le système de nettoyage du brasero (4) qui laisse libres les trous pour le passage de l'air. Le résultat est une combustion toujours efficace.

De reductiemotor (1) drijft de stang onder het vuurpotje (2) automatisch aan.

De stang beweegt op zijn beurt de turbulatoren die de rookgasleidingen (3) reinigen en drijft het reinigingssysteem van de vuurpot (4) aan dat de luchtopeningen vrijhoudt. Het resultaat is een altijd efficiënte verbranding.

Der Getriebemotor (1) aktiviert die Stange unter der Brennerschale (2) automatisch.

Diese bewegt ihrerseits die Turbulatoren, die die Rauchauslassrohre (3) reinigen und aktiviert das Reinigungssystem für die Brennerschale (4), sodass sich die Luftdurchlassöffnungen nicht verstopfen. Dies erzielt eine stets leistungsfähige Verbrennung.

The gear motor (1) automatically operates the bar placed under the burning pot (2).

The bar triggers the turbulators, which clean the smoke pipes (3) operating the brazier cleaning system (4) keeping the air flow passage holes clean, ensuring a more and efficient combustion at all times.



VYDA H



BLADE H



KIRA H

Grand tiroir à cendres
Ruime uitschuifbare aslade
 Großer, ausziehbarer Aschebehälter
Large removable ash container

THERMOPOÊLES À PELLETS
 PELLET-THERMOKACHELS
 WASSERGEFÜHRTER PELLETÖFEN
 PELLET THERMO-STOVES

Le système innovant **EKleaner** effectue automatiquement un double nettoyage du creuset et des turbulateurs. Pour un chauffage plus pratique et une combustion plus efficace.

*Het innovatieve systeem **EKleaner** voert automatisch een dubbele reiniging uit, van het vuurpotje en van de turbulatoren. Voor een praktischere verwarming en een efficiëntere verbranding.*

Das innovative System **EKleaner** führt in der Brennerschale und in den Turbulatoren eine automatische Doppelreinigung. Ergebnis ist eine praktischere Beheizung und leistungsfähigere Verbrennung.

*The innovative **EKleaner** system is automatically performing a double cleaning of the burning pot and the turbulators, for a smarter heating and a more efficient combustion.*



Acier et céramique noir brillant_ *Staal en Zwart glanzend keramiek*
Stahl und Glänzend schwarz Keramik_ *Steel and Glossy black ceramic*

Mito Idro

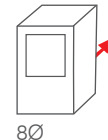

16,2 kW_11,8 kW(H₂O)_420 m³_52x55xh110 cm

THERMOPOÊLES À PELLETS
THERMOKACHELS OP PELLETS
WASSERGEFÜHRTE PELLETS-ÖFEN
PELLET THERMO-STOVES

_ Foyer en fonte et acier
_ Haard in staal en gietijzer
_ Feuerraum aus Gusseisen und Stahl
_ Cast iron and steel combustion chamber

Panneau_Paneel
Bedienfeld_Synoptic panel



Ventilation frontale air chaud
Ventilatie warme lucht vooraan
Frontal-Warmluftgebläse
Front hot air ventilation

Acier avec top et inserts en céramique
Staal met Inzetframe in keramiek
Stahl mit Einsätze aus Keramik
Steel with ceramic top and inserts



Céramique bordeaux
Bordeaux keramiek
Bordeaux Keramik
Bordeaux ceramic



Céramique parchemin
Pergament kleurig keramiek
Pergamentfarben Keramik
Parchment ceramic



Céramique blanc crème
Roomwit keramiek
Cremeweiß Keramik
Cream white ceramic





C ramique bordeaux *Bordeaux keramik*
Bordeaux Keramik *Bordeaux ceramic*

Mito Idro

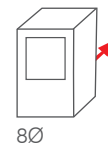

16,2 kW_11,8 kW(H₂O)_420 m³_52x55xh110 cm

THERMOPOÊLES À PELLETS
THERMOKACHELS OP PELLETS
WASSERGEFÜHRTE PELLETS-ÖFEN
PELLET THERMO-STOVES

_ Foyer en fonte et acier
_ Haard in staal en gietijzer
_ Feuerraum aus Gusseisen und Stahl
_ Cast iron and steel combustion chamber

Panneau_Paneel
Bedienfeld_Synoptic panel



Ventilation frontale air chaud
Ventilatie warme lucht vooraan
Frontal-Warmluftgebläse
Front hot air ventilation



Céramique blanc crème
Roomwit keramiek
Cremeweiß Keramik
Cream white ceramic



Céramique parchemin
Perkament kleurig keramiek
Pergamentfarben Keramik
Parchment ceramic



Cherie Up H

16,2 kW_11,8 kW(H₂O)_420 m³_62x57xh115 cm

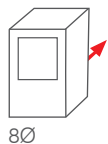

THERMOPOÊLES À PELLETS
 THERMOKACHELS OP PELLETS
 WASSERGEFÜHRTE PELLETS-ÖFEN
 PELLET THERMO-STOVES

- _ Foyer en fonte et acier
- _ Haard in staal en gietijzer
- _ Feuerraum aus Gusseisen und Stahl
- _ Cast iron and steel combustion chamber



Panneau synoptique
 Synoptisch paneel
 Versenkbares Bedienfeld
 Synoptic control panel



Acier gris foncé
 Donkergrijs stalen
 Dunkelgraue Stahl
 Dark grey steel



Acier bordeaux
 Bordeaux staal
 Bordeaux-Stahl
 Bordeaux steel



Acier bronze
 Brons staal
 Bronzefarbener Stahl
 Bronze steel



Acier blanc opaque
 Mat wit staal
 Mattweiße Stahl
 Opaque white steel





Pierre ollaire_ *Speksteen*
Naturstein_ *Soapstone*

Cherie Up H

16,2 kW_11,8 kW(H₂O)_420 m³_62x57xh115 cm

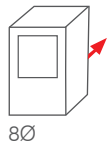

THERMOPOÊLES À PELLETS
 THERMOKACHELS OP PELLETS
 WASSERGEFÜHRTE PELLETS-ÖFEN
 PELLET THERMO-STOVES

_ Foyer en fonte et acier
 _ Haard in staal en gietijzer
 _ Feuerraum aus Gusseisen und Stahl
 _ Cast iron and steel combustion chamber



Panneau synoptique
 Synoptisch paneel
 Versenkbares Bedienfeld
 Synoptic control panel



Céramique bordeaux
 Keramiek bordeaux
 Keramik bordeaux
 Bordeaux ceramic



Céramique gris foncé
 donkergrijs keramiek
 Dunkelgraue Keramik
 dark grey ceramic



Céramique poivre et sel
 Keramiek peper en zout
 Keramik mit Salz-und-Pfeffer-Optik
 Salt and pepper ceramic



Céramique blanc crème
 Roomwit keramiek
 Cremeweiß Keramik
 Cream white ceramic





Verre noir_Zwart glas
Glas, schwarz_Black glass



Verre blanc
Wit glas
Glas, weiß
White glass



C ramique bordeaux_Keramik bordeaux
Keramik bordeaux_Bordeaux ceramic

C ramique blanc cr me
Keramik roomwit
Keramik cremewei 
Cream white ceramic

C ramique parchemin
Keramik perkament
Keramik pergamentfarben
Parchment ceramic

Idrosally*

16,2 kW_11,8 kW(H₂O)_420 m³_57x62xh110,5 cm

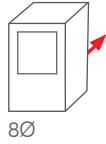

THERMOPOÊLES À PELLETS
 THERMOKACHELS OP PELLETS
 WASSERGEFÜHRTE PELLETS-ÖFEN
 PELLET THERMO-STOVES

- _ Foyer en acier
- _ Haard in staal
- _ Feuerraum aus Stahl
- _ Steel combustion chamber

* Jusqu'à épuisement des stocks / Zolang de voorraad strekt
 Solange der Vorrat reicht / While stocks last



Acer gris et céramique blanc crème
 Donkergrijs en keramiek roomwit
 Stahl dunkelgrau und Keramik cremeweiß
 Dark grey steel and white ceramic



Acer gris et céramique grise
 Donkergrijs en keramiek grijs
 Stahl dunkelgrau und grauer Keramik
 Dark grey steel and grey ceramic



Acer gris et céramique bordeaux
 Donkergrijs en keramiek bordeaux
 Stahl dunkelgrau und Keramik bordeaux
 Dark grey steel and bordeaux ceramic





C ramique blanc opaque / Matte witte keramiek
Mattwei er Keramik / Matt white ceramic



sistema
LEONARDO
Patented



Patent pending



option (EKleaner)
optioneel
Option
optional



New Vyda H Vyda H EKleaner

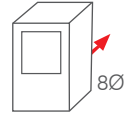

18,7 kW_16,3 kW(H₂O)_485 m³_62,5x61,5xh121,5 cm
22,5 kW_20 kW(H₂O)_585 m³_62,5x61,5xh121,5 cm

THERMOPOÊLES À PELLETS
THERMOKACHELS OP PELLETS
WASSERGEFÜHRTE PELLETS-ÖFEN
PELLET THERMO-STOVES

- _ Foyer en acier
- _ Haard in staal
- _ Feuerraum aus Stahl
- _ Steel combustion chamber

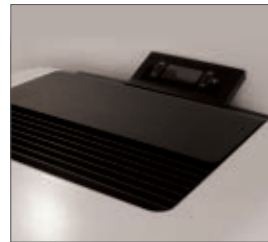

Panneau synoptique escamotable
Verborgen synoptisch paneel
Versenkbare Bedienfeld
Concealed synoptic control panel



Céramique gris foncé
Donkergrijze keramiek
Dunkelgrauer Keramik
Dark grey ceramic



Pierre ollaire
Speksteen
Speckstein
Soapstone

- Pour le bon fonctionnement il est indispensable l'installation de un des kits ci-dessous:
- Voor de juiste werking is de installatie van één van de onderstaande kits noodzakelijk:
- Die unten angegebenen vormmontierte Hydraulik-Bausätze müssen für eine korrekte Funktionsweise installiert werden:
- The undermentioned pre-assembled hydraulic kits have to be installed to ensure a correct operation:

Vyda 18: R - R2

Vyda 22: R - R2 - RW

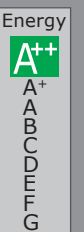

New Kira H

Kira H EKleaner

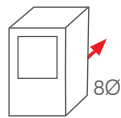

18,7 kW_16,3 kW(H₂O)_485 m³_65x63xh123,5 cm
 22,5 kW_20 kW(H₂O)_585 m³_65x63xh123,5 cm

THERMOPOÊLES À PELLETS
 THERMOKACHELS OP PELLETS
 WASSERGEFÜHRTE PELLETS-ÖFEN
 PELLET THERMO-STOVES

- _ Foyer en acier
- _ Haard in staal
- _ Feuerraum aus Stahl
- _ Steel combustion chamber



Panneau synoptique escamotable
 Verborgen synoptisch paneel
 Versenkbares Bedienfeld
 Concealed synoptic control panel



- Pour le bon fonctionnement il est indispensable l'installation de un des kits ci-dessous:
- Voor de juiste werking is de installatie van één van de onderstaande kits noodzakelijk:
- Die unten angegebenen vormmontierte Hydraulik-Bausätze müssen für eine korrekte Funktionsweise installiert werden:
- The undermentioned pre-assembled hydraulic kits have to be installed to ensure a correct operation:

Kira 18: R - R2

Kira 22: R - R2 - RW



Céramique blanc crème
 Roomwit keramiek
 Cremeweiß Keramik
 Cream white ceramic



Céramique parchemin
 Keramiek pergament
 Keramik pergamentfarben
 Parchment ceramic



C ramique bordeaux_Keramik bordeaux
Keramik bordeaux_Bordeaux ceramic



option (EKleaner)
optioneel
Option
optional

New Blade H Blade H EKleaner

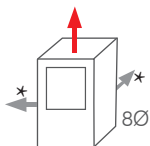

18,7 kW_16,3 kW(H₂O)_485 m³_104x39x120,5 cm

22,5 kW_20 kW(H₂O)_585 m³_104x39x120,5 cm

THERMOPOÊLES À PELLETS
THERMOKACHELS OP PELLETS
WASSERGEFÜHRTE PELLETS-ÖFEN
PELLET THERMO-STOVES

_Foyer en acier
_Vuurhaard in staal
_Feuerraum aus Stahl
_Steel combustion chamber

Panneau_Paneel
Bedienfeld_Synoptic panel

*
_vers l'arrière ou latérale gauche, en option
_achteraan of aan de zijkant links Optionele
_hinten oder seitlich links Option
_rear and left side Optional



- Pour le bon fonctionnement il est indispensable l'installation de un des kits ci-dessous:
- Voor de juiste werking is de installatie van één van de onderstaande kits noodzakelijk:
- Die unten angegebenen vormmontierte Hydraulik-Bausätze müssen für eine korrekte Funktionsweise installiert werden:
- The undermentioned pre-assembled hydraulic kits have to be installed to ensure a correct operation:

Blade H 18: R - R2

Blade H 22: R - R2 - RW

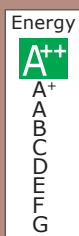

Acier bronze
Brons staal
Bronzefarbener Stahl
Bronze steel



Acier blanc opaque
Mat wit staal
Mattweiße Stahl
Opaque white steel



Acier bordeaux
Bordeaux Stalen
Stahl bordeaux
Bordeaux painted steel





sistema
LEONARDO
Patented



EKleaner
Patent pending



option (EKleaner)
optioneel
Option
optional



Acier noir _Zwart staal
Schwarzer Stahl _Black steel

New Blade H Blade H EKleaner

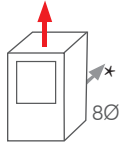

18,7 kW_16,3 kW(H₂O)_485 m³_106x39x122 cm

22,5 kW_20 kW(H₂O)_585 m³_106x39x122 cm

THERMOPOÊLES À PELLETS
THERMOKACHELS OP PELLETS
WASSERGEFÜHRTE PELLETS-ÖFEN
PELLET THERMO-STOVES

_Foyer en acier
_Vuurhaard in staal
_Feuerraum aus Stahl
_Steel combustion chamber

Panneau_Paneel
Bedienfeld_Synoptic panel

*
_vers l'arrière, en option
_achteraan, Optionele
_hinten, Option
_rear, Optional



- Pour le bon fonctionnement il est indispensable l'installation de un des kits ci-dessous:
- Voor de juiste werking is de installatie van één van de onderstaande kits noodzakelijk:
- Die unten angegebenen vormmontierte Hydraulik-Bausätze müssen für eine korrekte Funktionsweise installiert werden:
- The undermentioned pre-assembled hydraulic kits have to be installed to ensure a correct operation:

Blade H 18: R - R2

Blade H 22: R - R2 - RW

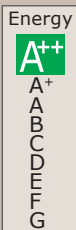

Céramique bordeaux
Bordeaux keramiek
Bordeaux Keramik
Bordeaux ceramic



Céramique blanc opaque
Keramiek mat wit
Keramik mattweiße
White ceramic



Céramique noir brillant
Zwart glanzend keramiek
Glänzend schwarz Keramik
Glossy black ceramic



LEONARDO
GEONIBDO
Patented

EKleaner
Patent pending



option (EKleaner)
optioneel
Option
optional



C ramique beige _Beige keramiek
Beige Keramik _Beige ceramic

Daisy

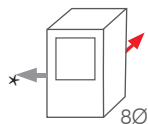

22,1 kW_15,1 kW(H₂O)_575 m³_100x43xh122 cm

THERMOPOÊLES À PELLETS
THERMOKACHELS OP PELLETS
WASSERGEFÜHRTE PELLETS-ÖFEN
PELLET THERMO-STOVES

_ Foyer en acier et Scamolex (vermiculite)
_ Vuurhaard in staal en Scamolex
_ Feuerraum aus Stahl und Scamolex
_ Steel and Scamolex combustion chamber

*
_ latérale gauche, en option
_ zijkant links Optionele
_ seitlich links Option
_ left side Optional



Céramique blanc crème
Keramik wit crème
Keramik kleur altweiß
Cream ceramic



Céramique bordeaux
Keramik bordeaux
Keramik bordeaux
Bordeaux ceramic





Céramique noir brillant_ *Keramik glanzend zwart*
Keramik Schwarz, glänzend_ *Shiny black ceramic*

Meg

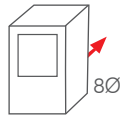

25 kW_19,2 kW(H₂O)_650 m³_59x61xh121 cm

THERMOPOÊLES À PELLETS
 THERMOKACHELS OP PELLETS
 WASSERGEFÜHRTE PELLETS-ÖFEN
 PELLET THERMO-STOVES

- _ Foyer en fonte
- _ Vuurhaard in gietijzer
- _ Feuerraum Gusseisen
- _ Cast iron combustion chamber



Céramique parchemin_Keramiek perkamentkleurig
 Keramik pergamentfarbene_Parchment ceramic



Céramique bordeaux
 Keramiek bordeaux
 Keramik bordeaux
 Bordeaux ceramic



Céramique blanc crème
 Keramiek wit crèmekleur
 Keramik altweiß
 Cream ceramic

Meg Più

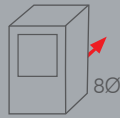

30,3 kW_25 kW(H₂O)_790 m³_59x68,5x121 cm

THERMOPOÊLES À PELLETS
 THERMOKACHELS OP PELLETS
 WASSERGEFÜHRTE PELLETS-ÖFEN
 PELLET THERMO-STOVES

- _ Foyer en fonte
- _ Vuurhaard in gietijzer
- _ Feuerraum Gusseisen
- _ Cast iron combustion chamber

- Pour le bon fonctionnement il est indispensable l'installation de un des kits ci-dessous:
- *Voor de juiste werking is de installatie van één van de onderstaande kits noodzakelijk:*
- Die unten angegebenen vormmontierte Hydraulik-Bausätze müssen für eine korrekte Funktionsweise installiert werden:
- *The undermentioned pre-assembled hydraulic kits have to be installed to ensure a correct operation:*

RS - RS2 - RWS - RWS2



Céramique blanc crème_Keramik wit crèmekleur
 Keramik altweiß_Cream ceramic



Céramique bordeaux
 Keramik bordeaux
 Keramik bordeaux
 Bordeaux ceramic



Céramique parchemin
 Keramik perkamentkleurig
 Keramik pergamentfarbene
 Parchment ceramic



Idropellbox

15,6 kW_12,6 kW(H₂O)_405 m³_72x56xh107/118 cm

THERMOCHEMINÉES À PELLETS
 THERMOHAARDEN OP PELLETS
 WASSERGEFÜHRTE PELLETS-KAMINEINSÄTZE
 PELLET THERMO-FIREPLACES



Chargement à l'aide du tiroir frontale
 Bijvullen via de lade voor frontaal
 Beladung mit vorderer Schublade
 Loading with frontal load tray

Energy
 A++
A+
 A
 B
 C
 D
 E
 F
 G

_Foyer en acier
 _Vuurhaard in staal
 _Feuerraum aus Stahl
 _Steel combustion chamber



Kit hydraulique incorporé_*Ingebouwde hydraulische kit*
 Eingebautes Hydraulikkit_*Built-in hydraulic kit*



Bloc foyer avec porte amovible pour faciliter le chargement et l'entretien de l'installation_
 Vuurhaard met te openen deur voor een eenvoudige toevoer van pellets en eenvoudig onderhoud aan de installatie_
 Brennraumeinheit mit Flügelöffnung das Beladen und die Instandhaltung der Anlage zu erleichtern_
 Firebox with openable door for easy maintenance and adjustment

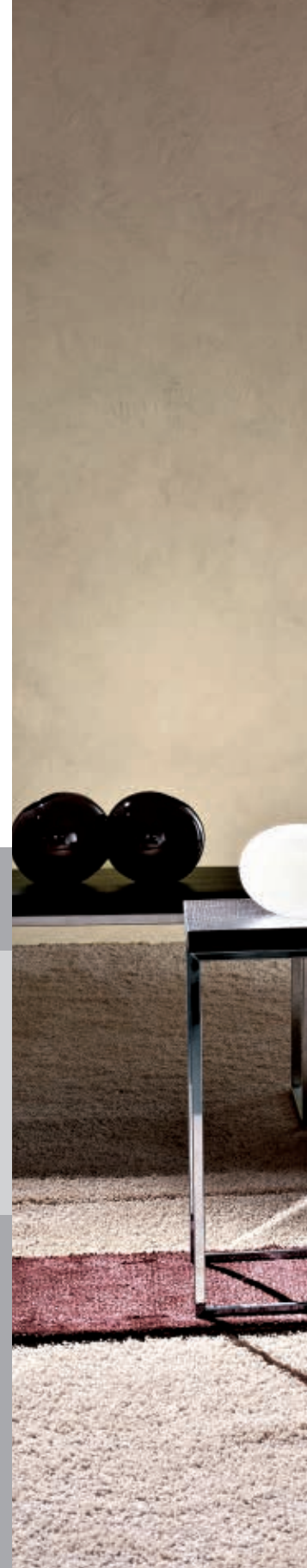



revêtement_bekledingen_Verkleidungen_covering - Fair (Idropellbox)

New Idropellbox 30

27 kW_22 kW(H₂O)_705 m³_97x60xh143 cm

THERMOCHEMINÉES À PELLETS
 THERMOHAARDEN OP PELLETS
 WASSERGEFÜHRTE PELLETS-KAMINEINSÄTZE
 PELLET THERMO-FIREPLACES



Energy
 A++
A+
 A
 B
 C
 D
 E
 F
 G

- _ Foyer en fonte
- _ Vuurhaard in gietijzer
- _ Feuerraum Gusseisen
- _ Cast iron combustion chamber

- _ Kit hydraulique incorporé
- _ Ingebouwde hydraulische kit
- _ Eingebautes Hydraulikkit
- _ Built-in hydraulic kit



- _ Kit chargement granulés par la trappe (en option)
- _ Kit pelletlading met bijvulluik (optie)
- _ Teilesatz Pelletzuführung über Einfüllrutsche (Option)
- _ Trapdoor loading kit (optional)



- _ Kit Air Diffuser "adjacent" en option
- _ Set Air Diffuser "dichtbij" optie
- _ "Nahegelegenes" Kit Air Diffuser Option
- _ Air Diffuser KIT "adjacent" optional



- _ Chargement du granulé par le coté droit ou gauche (à définir lors de l'installation)
- _ Pelletlading vanaf de rechter- of linkerkant (Te bepalen tijdens de installatie)
- _ Seitliche Pelletbefüllung rechts oder links (muss während der Installation bestimmt werden)
- _ Right or left pellet side-load (to be defined during installation)







LagunaP_{18/24/35}

CHAUDIÈRES À PELLETT
PELLETKETELS
PELLETS-HEIZKESSEL
PELLET BURNING BOILERS

- _ Foyer en acier
- _ Vuurhaard in staal
- _ Feuerraum aus Stahl
- _ Steel combustion chamber

- Pour le bon fonctionnement il est indispensable l'installation de un des kits ci-dessous:
- Voor de juiste werking is de installatie van één van de onderstaande kits noodzakelijk:
- Die unten angegebenen vormmontierte Hydraulik-Bausätze müssen für eine korrekte Funktionsweise installiert werden:
- The undermentioned pre-assembled hydraulic kits have to be installed to ensure a correct operation:

Laguna 18: R - R2

Laguna 18/24/35: R - R2 - RW - RW2



18 18,1 kW 16,5 kW (H₂O) m³ 430 76x79xh128 cm
24 24,4 kW 22 kW (H₂O) m³ 575 91x79xh128 h cm
35 34,1 kW 30,8 kW (H₂O) m³ 805 91x79xh128 h cm

- _ panneau tactile synoptique en couleurs
- _ programmation horaire hebdomadaire
- _ réservoir latéral 60 kg (Laguna P 18)
- _ réservoir latéral 100 kg (Laguna P 24/35)
- _ nettoyage automatique des turbulateurs, du foyer et expulsion automatique des cendres

- _ kleuren touchscreen synoptisch paneel
- _ programmering uren per week
- _ reservoir aan de zijkant 60 kg (Laguna P 18)
- _ reservoir aan de zijkant 100 kg (Laguna P 24/35)
- _ automatische reiniging van de turbulatoren, de vuurpot en automatische uitstoot van de as

- _ Farbiger Touch-Screen zur Übersicht
- _ Tägliche/wöchentliche Programmierung
- _ Seitlicher Tank 60 kg (Laguna P 18)
- _ Seitlicher Tank 100 kg (Laguna P 24/35)
- _ Automatische Reinigung des wärmetauschers, der Brennschale und automatische Austragung der Asche

- _ colour touch screen display
- _ weekly time programming
- _ 60 kg side tank (Laguna P 18)
- _ 100 kg side tank (Laguna P 24/35)
- _ automatic cleaning of tubing, brazier and automatic ash expulsion

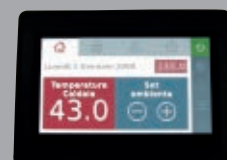
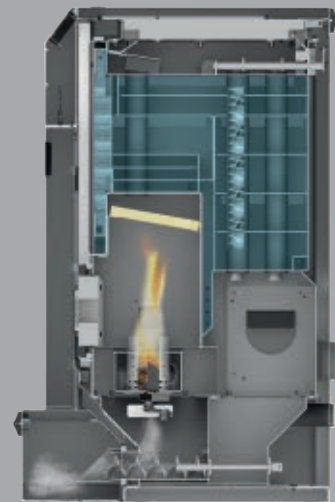



Laguna M_{25/33}

CHAUDIERES MULTI COMBUSTIBLES
MULTI BRANDSTOF KETELS
MEHRSTOFF-HEIZKESSEL
MULTI-FUEL BURNING BOILER

- _ Foyer en acier
- _ Vuurhaard in staal
- _ Feuerraum aus Stahl
- _ Steel combustion chamber

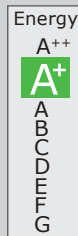

25 24,3 kW_{21,9 kW (H₂O)}_m³ 570_67x82xh136 cm
33 32 kW_{29,1 kW (H₂O)}_m³ 760_67x82xh136 cm

Données techniques concernant le combustible pellet
 Technische gegevens betreffende pelletbrandstof
 Auf den Brennstoff Pellet bezogene technische Daten
 Pellet technical data

Fonctionnement aux pellets ou aux d'olives, de cerises, coques d'amandes et de noisettes.

- _ réservoir 70 kg _panneau synoptique
- _ nettoyage automatique du creuset et des turbulateurs
- _ série d'équipements embarqués déjà configurés

Werkt met pellets of korrelige brandstoffen (zoals olijfpitten, kersen, amandel- en hazelnootschillen).

- _ reservoir 70 kg _synoptisch paneel
- _ automatische reiniging van de vuurpot en van de turbulatoren
- _ aantal systemen reeds geconfigureerd aan boord anlageschema

Funktioniert mit Pellets und granulösen Heizstoffen (beispielsweise in der Größe von Olivenkernen, Kirschkernen, Mandelkernen und Nüssen).

- _ Tank 70 kg _Bedienfeld
- _ Automatische Reinigung des Heizgaswirlers und des Schmelztiegels
- _ Anlagenserie bereits in der Maschine integriert

Runs on pellets or granular fuel (such as olive or cherry waste, almond or hazelnut shells).

- _ 70 kg tank _display
- _ automatic cleaning of crucible and tubing
- _ series of systems already configured on the appliance

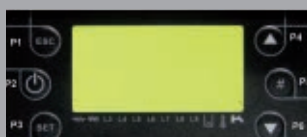



LagunaW Up 25/35

CHAUDIÈRES À BOIS
HOUT CV-KETELS
HOLZ-HEIZKESSEL
WOOD BURNING BOILERS

- _ Foyer en acier
- _ Vuurhaard in staal
- _ Feuerraum aus Stahl
- _ Steel combustion chamber



25 26,5 kW 24 kW (H₂O) m³ 625_62x110xh144 cm
35 34,7 kW 31,3 kW (H₂O) m³ 815_62x127xh144 cm

Technologie à flamme inversée

Sonde Lambda

- _ gazéification du bois et combustion à flamme inversée
- _ chambre de combustion à haut rendement
- _ système anti-fumée en phase de chargement
- _ tableau de commande électronique
- _ bûches de bois jusqu'à 33 cm (Laguna W 25)
- _ bûches de bois jusqu'à 50 cm (Laguna W 35)
- _ bypass fumées (sur l'ouverture du compartiment de chargement)
- _ serpentin de décharge thermique (pour installation à vase fermé)
- _ volet air primaire / secondaire
- _ accessoires de nettoyage

Omgekeerde vlam technologie

Lambda-sonde

- _ vergassing van het hout en verbranding met omgekeerde vlam
- _ verbrandingskamer met hoog rendement
- _ antirookstelsel in beladingsfase
- _ elektronisch bedieningspaneel
- _ houtblokken tot 33 cm (Laguna W 25)
- _ houtblokken tot 50 cm (Laguna W 35)
- _ by-pass rookgas op de opening van de laadruimte
- _ thermische afvoerlepel (voor de installatie met gesloten vat)
- _ afsluitklep primaire / secundaire lucht
- _ accessoires voor reiniging

Technologie mit umgekehrter Flamme

Lambda temp. probe

- _ Vergasung von Holz und Verbrennung mit umgekehrter Flamme
- _ Verbrennungskammer mit hoher Leistung
- _ Anti-Rauch-System bei der Beladung
- _ Elektronisches Schaltfeld
- _ Holzstücke bis 33 cm (Laguna W 25)
- _ Holzstücke bis 50 cm (Laguna W 35)
- _ Rauch-Bypass (auf der Öffnung des Laderaums)
- _ Rohrschlange als Rauchabzug für Wärmeenergie (Für die Installation bei geschlossenen Ausdehnungsgefäßen)
- _ Eingang für Primär-/Sekundär-Luft
- _ Zubehör für die Reinigung

Reversed flame technology

Lambdasonde

- _ gasification of wood and fuel with reversed flame
- _ high yield combustion compartment
- _ smoke prevention system during loading phase
- _ electronic command panel
- _ 33 cm nozzles (Laguna W 25)
- _ 50 cm nozzles (Laguna W 35)
- _ smoke by-pass (on loading compartment opening)
- _ thermal relief coil (for installation on closed tank)
- _ primary/secondary air shutter
- _ accessories for cleaning

ACCESSOIRES EN OPTION POUR CHARGEMENT _ACCESSOIRES OPTIONEEL VOOR TOEVOER_
ZUBEHÖR OPTION FÜR BEFÜLLUNG _OPTIONAL ACCESSORIES FOR LOADING

Réservoir en acier - *Stalen tanken* - *Stahltank* - *Steel tanks*



250 kg



500 kg

Réservoir avec structure en acier
Tank met stalen structuur
Tank mit Stahlstruktur
Tank with steel structure



*Kit avec capacité de 300 kg pour transformation réservoir de 500 kg à 800 kg
Kit met inhoud van 300 kg, voor transformatie tank van 500 kg naar 800 kg
Satz mit 300 kg Fassungsvermögen, zur Umwandlung eines Tank von 500 kg auf 800 kg
Kit with 300kg capacity for converting tank from 500 kg to 800 kg



**Kit avec capacité de 200 kg pour transformation réservoir de 800 kg à 1.000 kg/
Kit met inhoud van 200 kg, voor transformatie tank van 800 kg naar 1.000 kg/ Satz mit 200kg Fassungsvermögen, zur Umwandlung eines Tank von 800kg auf 1.000 kg/
Kit with 200kg capacity for converting tank from 800 kg to 1.000 kg

Systèmes mécaniques pour l'alimentation de granulés - *Mechanische systemen voor het bijvullen van pellet* - *Mechanische Systeme zur Pellet Beschickung* - *Mechanical pellet feeding systems*



90 cm

100 cm (Maxima)



150 cm



300 cm



500 cm

Vis avec moteur et accessoires/*Vulschroef met motor en accessoires/Schnecke mit Motor und Zubehör/*
screw feeder with motor and accessories



Kit collier pour suspension vis au plafond (tirants inclus)/*Kit met ring om de vulschroef op te hangen (inclusief trekstangen)/* Schellen-Satz zum Aufhängen der Schnecke an der Decke (Zuganker inklusive)/
Collar kit for hanging screw feeder from ceiling (including tie rods)



A

Silos à distance en tissu - *Remote stoffen silo* - *Gewebesilos* - *Remote silos in fabric*

Silos stockage pellet de 2,1 à 3,2 t. (A)/*Pelletopslag silo van 2,1 tot 3,2 t. (A)/* Gewebesilos von 2,1 bis 3,2 t. (A)/
Fabric silos from 2.1 to 3.2 t. (A)

Silos stockage pellet de 4,2 à 6,7 t./*Pelletopslag silo van 4,2 tot 6,7 t./* Gewebesilos von 4,2 bis 6,7 t./
Fabric silos from 4.2 to 6.7 t.

Systèmes pneumatique pour l'alimentation de granulés _*Pneumatisch systemen voor het bijvullen van pellet*_
Pneumatische Systeme zur Pellet Beschickung _*Pneumatic pellet feeding systems*



Unité pour extraction à aspiration (mécanique sans moteur ni vis)/*Zuigingsunit (mechanisch zonder motor en vulschroef)/*
Einheit für Saugabzug/ Extraction and suction unit

Système pneumatique pour le transport du pellet / *Pneumatisch pellets transportsysteem /*
Pneumatik-Anlage für den Pellettransport / *Pneumatic system for pellet transport*



Petit tapis amortisseur granulés (chargement pneumatique)/
Dempende steun voor pellet (pneumatisch laden)/
Pellet Dämpfmatte (pneumatische Beschickung)/
Pellet damper mat (pneumatic loading)



Kit embout pour remplissage avec accessoires _*SYSTÈME GUILLEMIN/*
Kit opening voor vullen met accessoires _ *GUILLEMIN-SYSTEEM/*
Einfüllstutzen-Set mit Zubehör _ *SYSTEM STORTZ/*
Filler nozzle kit with accessories _ *SYSTEM STORTZ*

Cubira Cubira cs

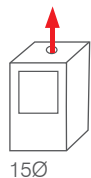

12,2 kW_7,5 kW(H₂O)_320 m³_55x55,5xh132 cm

THERMOPOÊLES À BOIS
HOUTTHERMOKACHELS
WASSERGEFÜHRTE-ÖFEN
BOILER STOVES

Foyer en acier et chamotte
Vuurhaard in staal en vuurvast materiaal
Feuerraum aus Stahl und Schamotte
Steel and refractory material combustion chamber

Cubira CS:

- _ pour installation à vase fermé (avec serpentin d'évacuation thermique incorporée).
- _ voor installatie met gesloten vat (met ingebouwde spiraal en veiligheidsklep)
- _ für Installation mit geschlossenem Ausdehnungsgefäß (mit eingebauter Rohrschlange für den Wärmeauslass).
- _ for installation with closed tank (with built-in thermal relief coil).

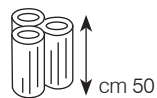

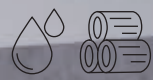

Acier noir avec inserts en acier inox *_zwart staal en inzetframe in inox staal_*
Schwarzer Stahl mit Einsätze aus inox Stahl *_Black steel with inox steel inserts*

Flamma Flamma cs

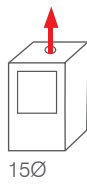

14,2 kW_9,7 kW(H₂O)_370 m³_63x56xh134 cm
23,6 kW_14,6 kW(H₂O)_615 m³_63x56xh134 cm

THERMOPOÊLES À BOIS
HOUTTHERMOKACHELS
WASSERGEFÜHRTE-ÖFEN
BOILER STOVES

Foyer en acier et chamotte
Vuurhaard in staal en vuurvast materiaal
Feuerraum aus Stahl und Schamotte
Steel and refractory material combustion chamber

Flamma CS:

- _ pour installation à vase fermé (avec serpentín d'évacuation thermique incorporée).
- _ voor installatie met gesloten vat (met ingebouwde spiraal en veiligheidsklep)
- _ für Installation mit geschlossenem Ausdehnungsgefäß (mit eingebauter Rohrschlange für den Wärmeauslass).
- _ for installation with closed tank (with built-in thermal relief coil).

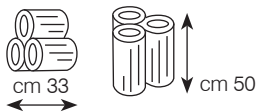

Céramique bordeaux
Bordeaux keramiek
Bordeaux-Keramik
Bordeaux ceramic



Céramique gris foncé
Donkergrijs keramiek
Dunkelgraue Keramik
Dark grey ceramic



Céramique parchemin
Pergament keramiek
Pergament-Keramik
Parchment ceramic





C ramique blanc cr me _ Roomwit keramiek
Sahnewei e-Keramik _ Cream white ceramic

Klima

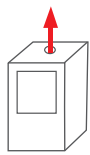

15Ø

19,7 kW_11,5 kW(H₂O)_515 m³_64x56xh108/127 cm

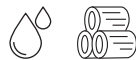

THERMOPOÊLES À BOIS
HOUTTHERMOKACHELS
WASSERGEFÜHRTE-ÖFEN
BOILER STOVES

Base - Chauffe-plats
Basis - Warmhoudplaat
Grundausführung - Warmhalteplatte
Basic - Food Warmer

_ Foyer en acier
_ Haard in staal
_ Feuerraum aus Stahl
_ Steel combustion chamber



Pierre ollaire_Speksteen_Naturstein_Soapstone



Pierre ollaire
Speksteen
Naturstein
Soapstone

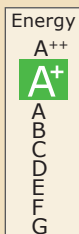



Warm

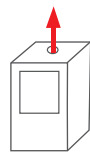

15Ø

19,7 kW_11,5 kW(H₂O)_515 m³_64x56xh108/127 cm

THERMOPOÊLES À BOIS
HOUTTHERMOKACHELS
WASSERGEFÜHRTE-ÖFEN
BOILER STOVES

Base - Chauffe-plats
Basis - Warmhoudplaat
Grundausführung - Warmhalteplatte
Basic - Food Warmer

_Foyer en acier
_Haard in staal
_Feuerraum aus Stahl
_Steel combustion chamber



Céramique ambre_Keramik amber_Keramik bernsteinfarben_Amber ceramic



Céramique bordeaux
Keramik bordeaux
Keramik bordeaux
Bordeaux ceramic





H₂Oceano15_15cs*

H₂Oceano23_23cs*

H₂Oceano28_28cs*

THERMOCHEMINÉES À BOIS
 HOUTTHERMOHAARDEN
 WASSERGEFÜHRTE HOLZ-KAMINEINSÄTZE
 WOOD THERMO-FIREPLACES



16,6 kW _ 8,2 kW (H₂O) _ 435 m³ _ 74x62xh135 cm
 23 kW _ 13,3 kW (H₂O) _ 600 m³ _ 88x68xh147 cm
 28,1 kW _ 17,4 kW (H₂O) _ 730 m³ _ 106x78xh147 cm

Post-combustion optimalede
 Optimale post-verbrandingdie
 Optimale nachverbrennung
 Optimal after-combustion

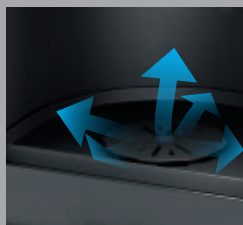

Grand plan feu et grille cendres en fonte
 Ruim brandvlak en asrooster in gietijzer
 Grosszügige brennfläche und aschenrost aus
 Gusseisen
 Wide fire surface and cast iron ash-pan



Kit hydraulique V monté sur la paroi
 extérieure
 Ophangbare hydraulische kit V,
 "Rucksack"-hydraulik-bausatz V
 "Backpack" hydraulic kit V

*
 _ pour installation à vase fermé (avec
 serpentin d'évacuation thermique incorporée).
 _ voor installatie met gesloten vat
 (met ingebouwde spiraal en veiligheidsklep)
 _ für Installation mit geschlossenem
 Ausdehnungsgefäß (mit eingebauter
 Rohrschlange für den Wärmeauslass).
 _ for installation with closed tank (with built-in
 thermal relief coil).

_ Foyer en fonte et acier
 _ Haard in staal en gietijzer
 _ Feuerraum aus Gusseisen und Stahl
 _ Cast iron and steel combustion chamber







Aquamaxi 28

THERMOCHEMINÉES À BOIS
HOUTTHERMOHAARDEN
WASSERGEFÜHRTE HOLZ-KAMINEINSÄTZE
WOOD THERMO-FIREPLACES



Energy
A++
A+
A
B
C
D
E
F
G

25,9 kW _ 13,8 kW (H₂O) _ 675m³ _ 108x66xh178 cm

Avec 1 serpentin _met 1 spiraal
mit 1 Rohrwendel _with 1 coil.
Avec 2 serpentins _met 2 spiralen
mit 2 Rohrwendeln _with 2 coils.

* Avec 1 serpentin et kit hydraulique fourni avec boîtier électronique (droit/gauche) *met 1 spiraal en hydraulische kit bijgeleverd met elektronische centrale (rechts/links)* mit 1 Rohrwendel plus Hydraulik-Bausatz, der im Lieferumfang des Schaltgeräts enthalten ist (rechts/links) *with 1 coil and plumbing kit supplied with electronic controller (right/ left).*

Foyer en acier et chamotte
Vuurhaard in staal en vuurvast materiaal
Feuerraum aus Stahl und Schamotte
Steel and refractory material combustion chamber

Alimentation de l'air de combustion dans le foyer distribué sur 3 circuits:
Toevoer van de verbrandingslucht in de kachel mogelijk via 3 circuits:
Die verbrennungsluft wird in drei kreise geteilt:
The combustion air is divided in three circuits:

- 1** Air primaire
Primaire lucht
Primäre Verbrennungsluft
Primary combustion air
- 2** Air secondaire ou de post-combustion
Secundaire lucht of naverbranding
Sekundäre Verbrennungsluft
Secondary combustion or post-combustion air
- 3** Air turbo
Lucht turbo
Turbo Luft
Turbo air

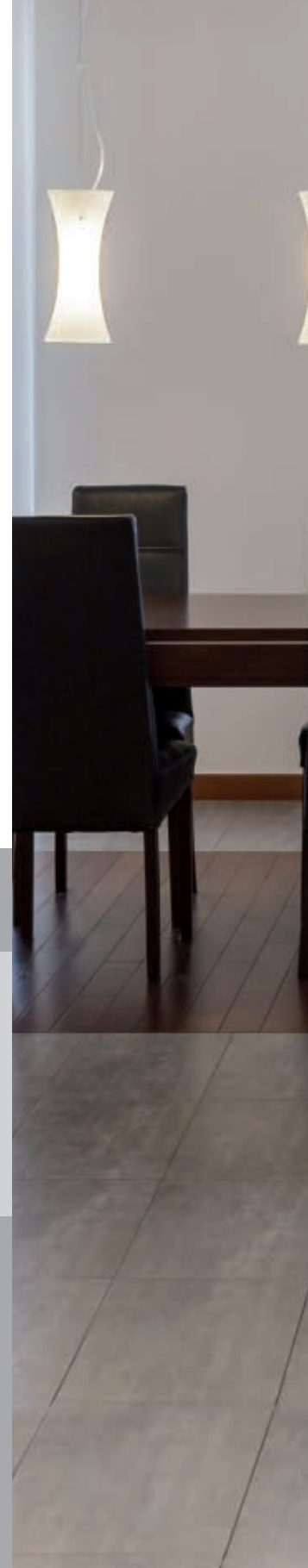





Acquatondo

Plus 22/22 cs*
Plus 29/29 cs*

THERMOCHEMINÉES À BOIS
HOUTTHERMOHAARDEN
WASSERGEFÜHRTE HOLZ-KAMINEINSÄTZE
WOOD THERMO-FIREPLACES



23 kW _ 13,3 kW (H₂O)_m³ 600_cm 80x68x138,5 h
28,1 kW _ 17,4 kW (H₂O)_m³ 730_cm 99x78x138,5 h

_ Foyer en fonte et acier
_ Haard in staal en gietijzer
_ Feuerraum aus Gusseisen und Stahl
_ Cast iron and steel combustion chamber

REVÊTEMENTS _ BEKLEDINGEN _ VERKLEIDUNGEN _ COVERINGS
Air, Bix Box, Dromond, Iron, Mexico, Sahara, Silver



Acquatondo

22
29/29 cs*

Prismatique _ Prismavormig _ Prismaförmig _ Prismatic

THERMOCHEMINÉES À BOIS
HOUTTHERMOHAARDEN
WASSERGEFÜHRTE HOLZ-KAMINEINSÄTZE
WOOD THERMO-FIREPLACES



23 kW _ 13,3 kW (H₂O)_m³ 600_cm 80x68x138,5 h
28,1 kW _ 17,4 kW (H₂O)_m³ 730_cm 99x78x138,5 h

_ Foyer en fonte et acier
_ Haard in staal en gietijzer
_ Feuerraum aus Gusseisen und Stahl
_ Cast iron and steel combustion chamber

REVÊTEMENTS _ BEKLEDINGEN _ VERKLEIDUNGEN _ COVERINGS
Air, Bix Box, Dromond, Iron, Mexico, Sahara, Silver

*
_ pour installation à vase fermé (avec serpentin d'évacuation thermique incorporée).
_ voor installatie met gesloten vat (met ingebouwde spiraal en veiligheidsklep)
_ für Installation mit geschlossenem Ausdehnungsgefäß (mit eingebauter Rohrschlinge für den Wärmeauslass).
_ for installation with closed tank (with built-in thermal relief coil).



Acquatondo 22

Sphérique_Bol_Sphärisch_Curved

THERMOCHEMINÉES À BOIS
HOUTTHERMOHAARDEN
WASSERGEFÜHRTE HOLZ-KAMINEINSÄTZE
WOOD THERMO-FIREPLACES



Energy
A++
A+
A
B
C
D
E
F
G

23 kW _ 13,3 kW (H₂O) _ m³ 600 _ cm 83x76x138,5 h

_ Foyer en fonte et acier
_ Haard in staal en gietijzer
_ Feuerraum aus Gusseisen und Stahl
_ Cast iron and steel combustion chamber

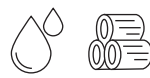

Acquatondo 29

Côte vitré_Een zijkant in glas_
Mit einer verglasten Seite_Glass on one side

THERMOCHEMINÉES À BOIS
HOUTTHERMOHAARDEN
WASSERGEFÜHRTE HOLZ-KAMINEINSÄTZE
WOOD THERMO-FIREPLACES



Energy
A++
A+
A
B
C
D
E
F
G

28,1 kW _ 17,4 kW (H₂O) _ m³ 730 _ cm 99x78x138,5 h

_ Foyer en fonte et acier
_ Haard in staal en gietijzer
_ Feuerraum aus Gusseisen und Stahl
_ Cast iron and steel combustion chamber



Air

- Acquatondo Plus 22, Forte Plus, cm 110x4x72 h.
- Cristal 76, Double, cm 110x4x76 h.
- Luce Plus 54, cm 106x4x75 h.
- Luce Plus 62, cm 106x4x81 h.
- Pellkamin 8/10, 106x4,5x75 h.



Bix box 100

- Flat 100 cm 130x26x76 h.



Arabesque

- Luce Plus 54, Pellkamin 8-10, cm 120x4x81 h.
- Luce Plus 62, cm 120x4x81 h.

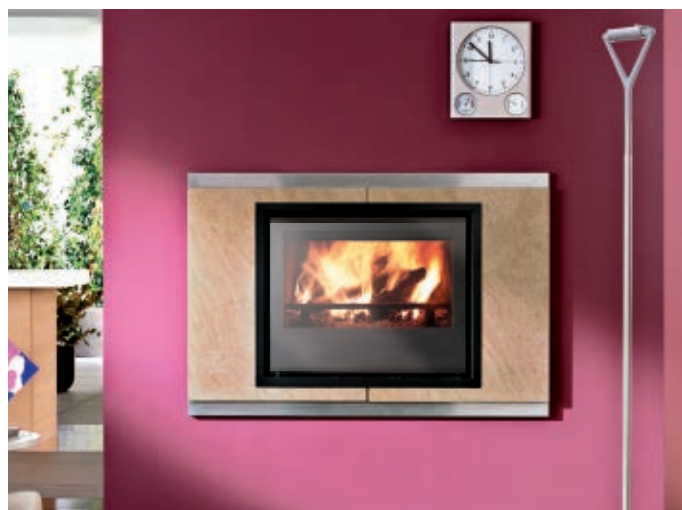

Arabesque

- Luce Plus 54, Pellkamin 8-10, cm 120x4x81 h.
- Luce Plus 62, cm 120x4x81 h.



Bix box

- Cristal 45 cm 72x26x103 h.
- Cristal 76, Double cm 103x26x85 h; Cristal 90 cm 117x26x98 h.
- Acquatondo Plus 22, Forte Plus, cm 104x6x81 h.



Bix box 62

- Luce Plus 62, cm 109x26x94 h.



Dromond

- Acquatondo Plus 22, Forte Plus, cm 131x38x172 h.
- Cristal 45 cm 100x38x174 h; • Cristal 76 cm 131x38x150 h;
- Cristal 90 cm 145x38x174 h.

Fair

- Idropellbox, cm 106x8x121 h;



Dromond

- Cristal 45 cm 100x38x174 h; • Cristal 76 cm 131x38x150 h.
- Cristal 90 cm 145x38x174 h.



Grey Up

- Screen EVO 80 cm 121x9x92 h;
- Screen Up 80 cm 121x9x92 h;
- Screen EVO 100 cm 141x9x92 h.
- Screen Up 100 cm 141x9x92 h.



High Tech

- Pellkamin 8-10, cm 120x7x105 h;
- Luce Plus 54, cm 120x7x105 h;
- Luce Plus 62, cm 120x7x105 h.



Incas

- Pellkamin 8-10, cm 122x7,5x149 h;
- Luce Plus 54, cm 122x8x149 h;
- Luce Plus 62, cm 132x8x157 h.



Iron

- Pellkamin 8-10, cm 108x9,5x 7 h;
- Luce Plus 54, cm 108x9x95 h;
- Luce Plus 62, cm 113x9x102 h;
- Acquatondo Plus 22, Forte Plus, cm 108x8x89 h;
- Acquatondo Plus 29 cm 116x8x89 h;
- Double- Cristal 76 cm 108x8x93 h;
- Flat 100 cm 135x8x85h

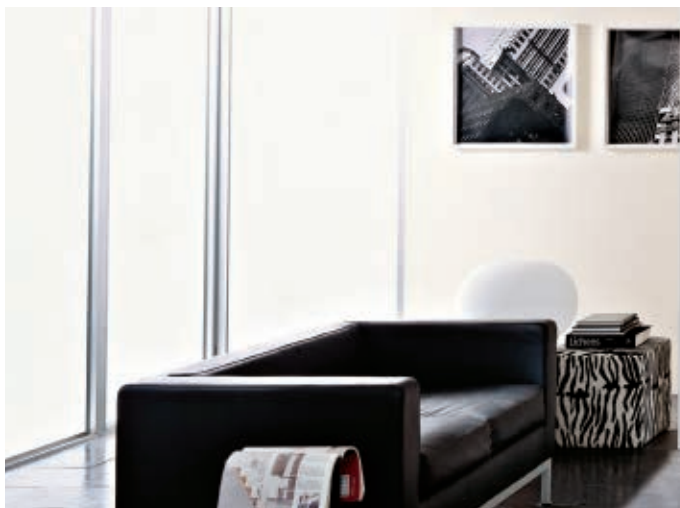

Laser

- Screen EVO 80, Screen Up 80, cm 145x5x106 h;
- Screen EVO 100, Screen Up 100, cm 165x5x106 h.



Mexico

- Acquatondo Plus 22, Forte Plus, Acquatondo Plus 29.



Nice

- Side Plus 50x50, 77x77x8 h.



Life

- Windo2 75, cm 123x91x107 h.
- Windo2 95, cm 143x91x107 h.



Sweet

- Side Plus 50x50, 100x83x36 h.



Sahara

- Pellkamin 8-10, cm 120x4x83 h;
- Luce Plus 54, cm 120x4x83 h; • Luce Plus 62, cm 123x4x88 h;
- Acquatondo Plus 22, Forte Plus, cm 123x4x82 h.



Sahara 100

- Flat 100 cm 171x7x98 h.



Silver

- Pellkamin 8-10, cm 102x4x88 h; • Double, Cristal 76 cm 102x3x87h; • Flat 100 cm 129x3x79h; • Luce Plus 54, cm 103x4x90 h • Luce Plus 62, cm 107x4x96h • Acquatondo Plus 22, Forte Plus, cm 102x3x83h, Acquatondo Plus 29 cm 110x3x83h.



Smile

- Screen EVO 80, Screen Up 80 cm 133x6x92 h;
- Screen EVO 100, Screen Up 100 cm 153x6x92 h.



Square

- Forte Plus, cm 160x25x160 h.



Square

- Forte Plus, cm 160x25x160 h.



Well

- Windo3 85, cm 138x74x99 h.



	DEMY (pellet) DEMY (bois/ hout/Holz/wood)	DAME Air Tight	MYA Air Tight MYA Air Tight C MYA ECO	ANIA Air Tight	NEA - LOU Air Tight	VYDA Air Tight VYDA Air Tight C	SLIDE SLIDE 7	BILD BILD Air Tight C	EVIA	KLIK
Kg	45	18	14 18	20	24	17	20	22	16	17
kW	3-10 5,1-10,9	2,2-6	2,4-6,3	2,4-8	2,4-8	3-10	2,3-4,9 2,3-7,1	4,4-9,1	2,4-8,2	3,5-8,3
Kg/h	0,7-2,3 1,3-2,8	0,5-1,4	0,5-1,5	0,5-1,8	0,5-1,8	0,7-2,3	0,5-1,1 0,5-1,6	1-2,1	0,5-1,9	0,8-1,9
h	20-64 /	13-36	9-28 12-36	11-40	13-48	7-24	18-40 13-40	10-22	8-32	9-21
m³	260 285	155	165	210	210	260	130 185	235	215	215
%	90 85,8	88	90,1	90,1	93	90,4	90,2 90,7	89	91,5	90
cm	15 F ↗	8 M ↑	8 M ↗ 8-13 F ↗ 8 M ↗	8 M ↗	8 M ↗	8M ↗ 8-13F ↑	8 M ↑ 8 F ↑	8F ↑ 8-13F ↑	8F ↑	8M
cm	/	1x Ø 8 cm	/	/	/	/	/	1X Ø 8 cm	/	/
Kg	292	254	171 167	198 204	208 204	164	121-132	130	150	140
SL	SL eBrusher	•	•	•	•	•	•	•	•	•
	•	•	•	•	•	•	•	•	•	•
	•	•	•	•	•	•	•	•	•	•
	/	•	/	/	/	/	/	/	/	•
GSM	•	•	•	•	•	•	•	•	•	•
Wi-Fi	/	•	•	•	•	•	•	•	•	•
	•	•	•	•	•	•	•	•	•	•
	•	•	•	•	•	•	•	•	•	optional
	R	S	G	G	S	G	G	G	G	G
NIGHT	/	/	MYA AT MYA ATC	/	/	•	•	•	•	optional
RELAX	/	/	MYA AT MYA ATC	/	/	•	•	•	•	•
AT	/	•	MYA AT MYA ATC	•	•	•	/	BILD ATC	/	/
Energy	A+	A+	A+	A+	A++	A+	A+	A+	A+	A+

LÉGENDE SYMBOLES/ SYMBOOL LIJST / SYMBOL ANGABE/ SYMBOLS KEY

Réservoir / Tank
Pelletbehälter / Pellet hopper

Rendement / Rendement
Wirkungsgrad/ Efficiency

Sistema Leonardo

M - mâle/mannelijk/feder/male
F - femelle/vrouwelijk/nut/female

kW min-max

Sortie fumées / Rookgasafvoer /
Rauchauslässe/ Smoke outlet

E-Brusher

Consommation / Verbruik /
Verbrauch / Consumption min-max

Sortie air chaud / Uitgang warmte lucht/
Warmluftauslass / Hot air outlet n° x Ø cm

Maison passives / Passiefhuis / Pssivhäuser / Passive house

Autonomie/Brandduur
Autonomie/Autonomy min-max

Poids avec emballage / Gewicht met verpakking-
smateriaal / Gewicht / Weight with packaging

Régulateur automatique de la combustion / Automatische regelaar
van de verbranding / Automatischer Verbrennungsregler
Automatic combustion control

Volume de chauffe / Verwarmbaar vol.
Beheizbarer Rauminhalt / Heatable volume

Panneau synoptique / Synoptisch paneel
Bedienfeld / Synoptic panel

Autoclean: Nettoyage automatique du creuset / Automatische reiniging
van de vuurpot / Automatische Reinigung des Brenntiegels
Automatic combustion chamber cleaning



JANE	LILLE	NARA NARA PLUS	KIKKA	ARIS UP ARIS UP PLUS	LOGO	TINY	SALLY SALLY PLUS	CHERIE UP	BLADE	VYDA KIRA	PELLKAMIN 8 PELLKAMIN 10 PELLKAMIN 12
20	20	24	15	15	20	20	25	26	22	30	11 11 17
2,3-4,9	2,4-5 2,4-8,1	2,3-7,1 2,7-9	2,4-8	2,4-8 2,5-8	2,7-9,1	2,8-9	3,5-12	5,5-11,2	3,5-12,1	4,2-14,3	3,1-8,1 3,1-10,4 3,4-12,1 0,7-1,9 0,7-2,4 0,7-2,8
0,5-1,1	0,5-1,1 0,5-1,9	0,5-1,6 0,6-2,1	0,5-1,8	0,5-1,8 0,6-1,8	0,6-2,1	0,6-2	0,8-2,8	1,2-2,6	0,8-2,8	1-3,3	6-16 5-16 6-24 210 270 315 91,1 90 90,2
18-40	18-40 11-40	15-48 11-40	8-30	8-30 8-25	10-33	10-33	9-31	10-22	8-28	9-30	210 270 315 91,1 90 90,2
130	130 210	185 235	210	210	235	235	315	290	315	375	91,1 90 90,2
90,2	91,1 90	90,7 90,2	90,1	90,1 91,5	90,1	94,1	90	90	90,3	90	8 M ↑
8 M ↗	8 F ↑ 8 M ↗	8 M ↗	8 M ↗ L/R	8 M ↗	8 M ↗	8 M ↗ R	8 M ↗	8 M ↗	8 F ↑	8 M ↗	8 M ↑
/	/	1x Ø 6 cm	/	1x Ø 8 cm	/	1x Ø 10 cm	1x Ø 10 cm	2x Ø 8 cm	1/2x Ø 6 cm	2x Ø 8 cm	/ / 2x Ø 10 cm pg.76
120	196	123	133	147-177 160-193	202	217	224-233 226-237	207-244	185-215	180 267	151 147 218-273
•	•	•	/	•	•	•	•	•	•	•	•
•	•	•	•	•	•	•	•	•	•	•	•
•	•	•	•	•	•	•	•	•	•	•	•
/	/	/	•	/	•	/	/	•	/	/	/
•	•	•	•	•	•	•	•	•	•	•	•
•	•	•	/	•	•	•	•	•	•	•	•
•	•	•	•	•	•	•	•	•	•	•	•
•	•	•	•	•	•	•	•	•	•	•	•
G	G	G	A-G	G	G	G	A-G	G	G	G	G
•	•	•	/	•	/	/	/	•	•	•	/
•	•	•	/	•	/	/	/	•	•	•	/
/	/	/	/	/	/	/	/	/	/	/	/
A+	A+	A+	A+	A+	A+	A++	A+	A+	A+	A+	A+

Gestion à distance / *Beheer op afstand*
Fernsteuerung / *Remote management*

Wi-Fi kit: en option / optioneel kit /
Zusatzausstattung / optional kit

Confortclima

Programmeur horaire hebdomadaire / *Week-urprogrammering* /
Wöchentliche Stunden-Programmierung / *Weekly time programmer*

Foyer / *Haard* / Brennraum / *Hearth*
G: Fonte / *Gietijzer* / Gußeisen / *Cast Iron*
R: Chamotte / *Hittebestendig materiaal* / *Schamotte* / *Refractory*
A: Acier / *Staal* / Stahl / *Steel* S: Scamolex (vermiculite)

Fonction NIGHT / *NIGHT-Functie* /
NIGHT Funktion / *NIGHT function*

Fonction RELAX / *RELAX-Functie* /
RELAX Funktion / *RELAX function*

Poêles «étanches»/De "luchtdichte" kachels
Raumluftunabhängige Öfen/"Airtight" stoves

Catégories d'efficacité énergétique
Energy efficiency classes
Energieeffizienzklassen
Energy efficiency classes

Energy A++ A+ A B C D E F G	Energy A++ A+ A B C D E F G	Energy A++ A+ A B C D E F G
--	--	--



	TALLY TALLY UP TALLY S TALLY UP S	FIORD	LILIA / L	VIP BIG	LUCE PLUS 54 LUCE PLUS 62	INWOOD INWOOD2 INWOOD3	WINDO 3 P50	WINDO 2 75 95	
kW	6,6	8	6,6	11,5	9 10,7	9	12	13,2 14,7	
Kg/h	1,7	2	2	3,2	2,5 2,9	2,5	3,4	3,4 3,9	
m³	170	210	170	300	235 280	235	315	345 385	
%	85,6	85,6	73,2	77,2	77,9 79,4	78,9	75,9	84,6 81	
cm	15 M ↗	15 M ↗	13 M ↑	15 M ↗	20 M ↑	15F ↗	20 F ↑	20 F ↑	
cm	1x Ø 10 cm	1x Ø 10 cm	/	2x Ø 10 cm	2x Ø 14 cm	2x Ø 14 cm cm 10 Airdiffuser	4x Ø 14 cm	4x Ø 14 cm	
Kg	171/245 158/246 238/330+40 178/274+40	150	140	244 244	126 144	125 — 130 — 135 —	348	336 380	
	/	/	/	•	•	•	/	/	
	•	•	•	/	•	•	/	/	
	S 29x23x39h	S 29x23x39h	G 30x30x24h	E 26x31x25h	G 55x38x29h 57x38x29h	S / R	R 38x70x51h	R 67x36x44h 87x36x44h	
	•	•	/	/	•	•	•	•	
	/	/	/	•	/	•	/	/	
Energy	A+	A+	A	A	A	A	A	A+	

LÉGENDE SYMBOLES/ SYMBOOL LIJST / SYMBOL ANGABE/ SYMBOLS KEY

kW min-max

Rendement / Rendement
Wirkungsgrad/ Efficiency

Ventilation Forcée / Geforceerde Ventilatie
Gebäsebelüftung / Forced ventilation (V)

Consommation / Verbruik /
Verbrauch / Consumption min-max

Sortie fumées / Rookgasafvoer /
Rauchauslässe/ Smoke outlet

Convection Naturelle / Natuurlijke Convectorie
Natuurliche belüftung / Natural convection (N)

Volume de chauffe / Verwarmbaar vol.
Beheizbarer Rauminhalt / Heatable volume

Sortie air chaud / Uitgang warmte lucht/
Warmluftauslass / Hot air outlet n° x Ø cm

Foyer / Haard / Brennraum / Hearth
G: Fonte / Gietijzer / Gußeisen / Cast Iron
R: Chamotte / Hitzebeständig materiaal / Schamotte / Refractory
A: Acier / Staal / Stahl / Steel S: Scamolex (vermiculite)

Poids avec emballage / Gewicht met verpakking-
smateriaal / Gewicht / Weight with packaging

Postcombustion / Shoon / verbrandingssysteem / Nachverbrennung /
Clean Combustion System

M - mâle/mannelijk/feder/male
F - femelle/vrouwelijk/nut/female



	WINDO 3 85	SIDE PLUS 50X50	CRISTAL 45 CRISTAL 76 CRISTAL 90	FLAT 100 FLAT 120	DOUBLE	SCREEN EVO 80 100	SCREEN UP 80 100	FORTE PLUS TITANO PLUS	STATUS PLUS
kW	13,2	12,4	13 15 20,1	12 14	12	13 14,6	13 14,6	19 18,5	16
Kg/h	3,4	3,3	3,7 4,2 5,3	4 4,7	3,9	3,7 3,8	3,7 3,8	5,7 5,6	4,8
m³	345	325	340 390 525	315 365	315	340 380	340 380	495 480	415
%	84,6	81,8	76,1 77,9 82,6	65,3 65,3	67,6	75,6 84,5	75,6 84,5	72,7 71,9	71,9
cm	20 F ↑	18 F ↑	20 F ↑ 25 F ↑ 25 F	25 F ↑ 30 F ↑	25 F ↑	20 F ↑	20 F ↑	25 F ↑	25 F ↑
cm	4x Ø 14 cm	1x Ø 14 cm	2x Ø 14 cm 2x Ø 14 cm 4x Ø 14 cm	4x Ø 14 cm	2x Ø 14 cm	2x Ø 14 cm	2x Ø 14 cm	4x Ø 14 cm	4x Ø 14 cm
Kg	350	230	260 308 368	350 367	343	167 200	165 197	305-310 293-303	287-292
	/	•	•	•	•	/	/	/	/
	/	•	•	•	•	•	•	•	•
	R 69x36x43h	R 40x40x49h	E 37x35x78h 68x37x60h 82x34x72h	E 130x38x50h 120x38x50h	E 68x37x60h	R 73,2x40x44h 93x40x44h	R 73,2x40x44h 93x40x44h	G 64x46x38h G 75x45x38h	G 74x45x49h
	•	•	•	•	•	•	•		•
Energy	A+	A+	A A A+	A	A	A A+	A A+	A	A

Energy Catégories d'efficacité énergétique
Energy efficiency classes
Energieeffizienzklassen
Energy efficiency classes

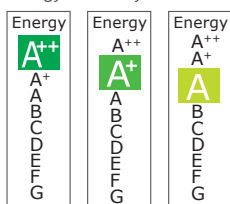



	IDROSALLY	MITO IDRO	CHERIE UP H	VYDA H	KIRA H	DAISY
Kg	25	30	29	37	37	30
kW	4,8-16,2	4,8-16,2	4,8-16,2	4,9-18,7 4,9-22,5	4,9-18,7 4,9-22,5	6,4-22,1
kW	/	/	/	/	/	/
kW H ₂ O	3-11,8	3-11,8	3-11,8	3,8-16,3 3,8-20	3,8-16,3 3,8-20	3,7-15,1
Kg/h	1-3,7	1-3,7	1-3,7	1,1-4,2 1,1-5,1	1,1-4,2 1,1-5,1	1,4-5
h	7-25	8-30	8-29	9-34 7-34	9-34 7-34	6-21
m ³	420	420	420	485 585	485 585	575
%	91,6	91,6	91,6	93,3 92,7	93,3 92,7	91,3
cm	8 M ↗	8 M ↗	8 M ↗	8 M ↗	8 M ↗	8 M ↗ ↘ ↙ ↚
Kg	247-257	221-242	230-265	260	280	308
SL	•	•	•	•	•	•
	•	•	•	•	•	•
	•	•	•	•	•	•
	/	•	• touch	•	•	/
GSM	•	•	•	•	•	•
Wi-Fi	•	/	•	•	•	•
	•	•	•	•	•	•
	•	•	•	•	•	•
	12	12	12	20	20	18
	A	A-G	A-G	A	A	A-S
	•	•	•	/	/	•
	/	/	/	•	•	/
Energy	A+	A+	A+	A++	A++	A+

LÉGENDE SYMBOLES/ SYMBOOL LIJST / SYMBOL ANGABE/ SYMBOLS KEY

M - mâle/mannelijk/feder/male
F - femelle/vrouwelijk/nut/female

Réservoir / Tank
Pelletbehälter / Pellet hopper

Volume de chauffe / Verwarmbaar vol.
Beheizbarer Rauminhalt / Heatable volume

Régulateur automatique de la combustion / Automatische regelaar
van de verbranding / Automatische Verbrennungsregler
Automatic combustion control

kW min-max Eau / Water /
Wasser / Water

Rendement /Rendement
Wirkungsgrad/ Efficiency

Autoclean: Nettoyage automatique du creuset / Automatische reiniging
van de vuurpot / Automatische Reinigung des Brenntiegels
Automatic combustion chamber cleaning

kW Puissance au foyer /
Vermogen van de vuurhaard /
Feuerungswärmeleistung /Power(input)

Sortie fumées / Rookgasafvoer /
Rauchauslässe/ Smoke outlet

Panneau synoptique / Synoptisch paneel
Bedienfeld / Synoptic panel

Consommation / Verbruik /
Verbrauch / Consumption min-max

Poids avec emballage / Gewicht met ver-
pakkingsmateriaal / Gewicht / Weight with
packaging

Gestion à distance / Beheer op
afstand / Fernsteuerung / Remote
management

Autonomie/Brandduur
Autonomie/Autonomy min-max

Sistema Leonardo

Wi-Fi kit: en option / optioneel kit / Zusatzausstat-
tung / optional kit



	BLADE H	MEG	MEG PIÙ	IDROPELLBOX	IDROPELLBOX30*	
Kg	30	40	40	30	60	
kW	4,9-18,7 4,9-22,5	7-25	9-30,3	4,5-15,6	7,5-27	
kW	/	/	/	-	-	
kW H ₂ O	3,8-16,3 3,8-20	6-19,2	6,5-25	3,1-12,6	6,5-22	
Kg/h	1,1-4,2 1,1-5,1	1,5-5,5	2-6,8	1-3,5	1,7-6,1	
h	7-27 6-27	7-27	6-20	9-30	10-35	
m ³	485 585	650	790	405	705	
%	93,3 92,7	94,5	92,2	92,1	91,5	
cm	8 F ↑	8 M ↗	8 M ↗	8 M ↑	10 M	
Kg	258-306 259-307	299	339	201	220	
SL	•	•	•	•	•	
	•	•	•	•	•	
	•	•	•	•	•	
	•	/	/	•	/	
GSM	•	•	•	•	•	
Wi-Fi	•	•	•	•	•	
	•	•	•	•	•	
CHECK	•	•	•	•	•	
	•	•	•	•	•	
	20	18	35	15	50	
	A	A-G	A-G	A	R	
	/	•	/	•	•	
	•	/	•	/	/	
Energy	A++	A++	A++	A+	A+	

** Données de projet/Projectgegevens/Projektdaten/Project data
* En cours de certification/In afwachting van certificering/In der Zertifizierungsphase/Certification in progress



Confortclima



Autocheck à froid: permet d'identifier des inconvénients éventuels
Autocheck hiermee kunnen eventuele storingen worden vastgesteld
Autocheck: Automatischer Reinigung des Brenntiegels
Cold autocheck: allows identification of any problems



Programmeur horaire hebdomadaire / Week-uurprogramming /
Wöchentliche Stunden-Programmierung / Weekly time programmer



Contenu d'eau / Waterinhoud
Wasserinhalt / Water capacity



Foyer / Haard / Brennraum / Hearth
G: Fonte / Gietijzer / Gußeisen / Cast Iron
R: Chamotte / Hitzebeständig materiaal / Schamotte / Refractory
A: Acier / Staal / Stahl / Steel S: Scamolex (vermiculite)



Kit incorporé avec vase d'expansion fermé, circulateur et groupe de sécurité.
Ingebouwde hydraulische kit met gesloten expansievat, circulatiepomp en overdrukklep.
Integrierter Hydraulikbausatz mit geschlossenem Ausdehnungsgefäß, Umwälzpumpe und Überdruckventil.
Incorporated hydraulic kit with closed expansion tank, circulator pump and pressure relief valve.



Vase d'expansion fermé/gesloten vat/
Geschlossene Ausdehnungsgefäß/
Closed tank



Catégories d'efficacité énergétique
Energy efficiency classes
Energieeffizienzklassen
Energy efficiency classes





	LAGUNA M [*] 25	LAGUNA M [*] 33	LAGUNA P 18	LAGUNA P 24	LAGUNA P 35	LAGUNA W UP 25	LAGUNA W UP 35
Kg	70	70	60	100	100	/	/
kW	/	/	/	/	/	/	/
kW	24,3	32	18,1	24,4	34,1	26,5	34,7
kW _{H₂O}	6,4-21,9	8,7-29,1	3,2-16,5	6,1-22	6,1-30,8	24	31,3
Kg/h	1,5-5,1	2-6,7	0,7-3,8	1,4-5,1	1,4-7,1	6	7,5
h	14-47	10-35	16-86	20-71	14-71	/	/
m ³	570	760	430	575	805	625	815
%	90	91	91,2	90,3	90,2	90,7	90,2
cm	10 M ↗	10 M ↗	10 M ↗	10 M ↗	10 M ↗	15 M ↗	15 M ↗
Kg	305	305	350	364	364	520	605
SL	/	/	SL	SL	SL	/	/
	•	•	•	•	•	/	/
	•	•	•	•	•	/	/
	/	/	• touch	• touch	• touch	/	/
GSM	/	/	/	/	/	/	/
Wi-Fi	/	/	/	/	/	/	/
	•	•	•	•	•	/	/
CHECK	•	•	•	•	•	/	/
	•	•	•	•	•	•	•
	54	54	65	65	65	117	133
	A	A	A	A	A	A	A
	•	•	/	/	/	/	/
	/	/	•	•	•	/	/
Energy	A+	A+	A+	A+	A+	A+	A+

^{*} Attention! Données techniques concernant le combustible pellet
 Let op! Technische gegevens betreffende pelletbrandstof
 Achtung! Auf den Brennstoff Pellet bezogene technische Daten
 Attention! Pellet technical data

Pour le calcul de la consommation de combustible, on a utilisé une puissance calorifique de:
 Voor de berekening van het brandstofverbruik werd een calorisch vermogen gebruikt van:
 Zur Berechnung des Brennstoffverbrauchs wird ein Heizwert von:
 The calculation of fuel consumption assumes a calorific value of :

4,6 kW/kg

4,8 kW/kg



	CUBIRA CUBIRA CS	FLAMMA / CS 14 24	KLIMA WARM
kW	12,2	14,2 23,6	19,7
kW H ₂ O	7,5	9,7 14,6	11,5
Kg/h	1,4-3	3,5 6,1	5,3
m ³	320	370 615	515
%	87,4	87,4 84,6	80,7
cm	15 F ↑	15 M ↑	15 M ↑
Kg	228 232 cs	278 283 cs	275/305* 250/274* *Chauffe-plats/ Warmhoudplaat/ Warmhalteplatte/ Food warmer
	30	40	40
	A 33x34x38h	A 33x34x38h	A 34x33x44h
Energy	A+	A+	A+

	AQUAMAXI 28	H ₂ OCEANO 15 23 28	ACQUATONDO ACQUATONDO PLUS 22	ACQUATONDO ACQUATONDO PLUS 29
kW	25,9	16,6 23 28,1	23	28,1
kW H ₂ O	13,8	8,2 13,3 17,4	13,3	17,4
Kg/h	7,2	4,4 6,1 7,5	6,1	7,5
m ³	675	435 600 730	600	730
%	77,9	83,1 82,2 81,5	82,2	81,5
cm	25 F ↑	18 F 22 F ↑ 25 F	20 F ↑	25 F ↑
Kg	475	246-251 cs 297-303 cs 302-308 cs	234-249 cs	302-311 cs
	90	75 100 130	70	90
	A/R 73x45x48h	A 52x40x40h 60x50x40h 78x63x40h	A 56x47x50h	A 74x55x50h
Energy	A	A+	A+	A+

LÉGENDE SYMBOLES/ SYMBOOL LIJST / SYMBOL ANGABE/ SYMBOLS KEY

kW min-max

Volume de chauffe /
Verwarmbaar vol.
Beheizbarer Rauminhalt /
Heatable volume

Poids avec emballage / Gewicht
met verpakkingsmateriaal / Gewicht
/ Weight with packaging

Energy

Catégories d'efficacité énergétique
Energy efficiency classes
Energieeffizienzklassen
Energy efficiency classes pg. 8

Eau / Water /
Wasser / Water

Rendement /Rendement
Wirkungsgrad/ Efficiency

Contenu d'eau / Waterinhoud
Wasserinhalt / Water capacity

Consommation / Verbruik /
Verbrauch / Consumption
min/max

Sortie fumées / Rookgasafvoer /
Rauchauslass / Smoke outlet

Foyer / Haard / Brennraum / Hearth
G: Fonte / Gietijzer / Gußeisen / Cast Iron
R: Chamotte / Hitzebeständig materiaal / Schamotte / Refractory
A: Acier / Staal / Stahl / Steel S: Scamolex (vermiculite)

Energy	Energy	Energy
A++	A++	A++
A+	A+	A+
A	A	A
B	B	B
C	C	C
D	D	D
E	E	E
F	F	F
G	G	G

Le volume de chauffe est calculé sur la base d'une nécessité de 33 kcal/m³h. Ce volume peut donc varier sensiblement selon le degré d'isolation de l'habitation, son exposition, sa zone climatique, etc.

Het verwarmde volume wordt berekend op basis van een behoefte van 33 kcal/m³h. Hetzelfde volume kan dus gevoelig variëren naargelang de isolatiegraad van de woning, van de ligging, van de klimaatzone, enz.

Das heizbare Volumen wird auf Grundlage eines Bedarfs von 33 kcal/m³h berechnet. Dies Volumen kann aber spürbar variieren und zwar in Abhängigkeit davon, wie die Wohnung isoliert wurde, wie sie liegt, in welcher Klimazone sie sich befindet etc.

The heatable volume is calculated based on a requirement of 33 kcal/m³h. The same volume may therefore vary considerably depending on the level of insulation in the home, its exposure, the climatic area, etc.

POÊLE BICOMBUSTIBLE_COMBIKACHEL
ZWEIFACH-BRENNSTOFF-OFEN_DUAL COMBUSTION STOVE

POÊLES À PELLETS_PELLETKACHELS
PELLETS-ÖFEN_PELLET STOVES

Demy

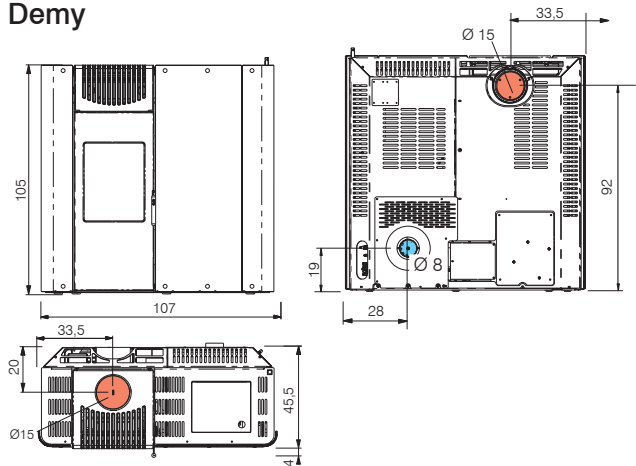

Dame

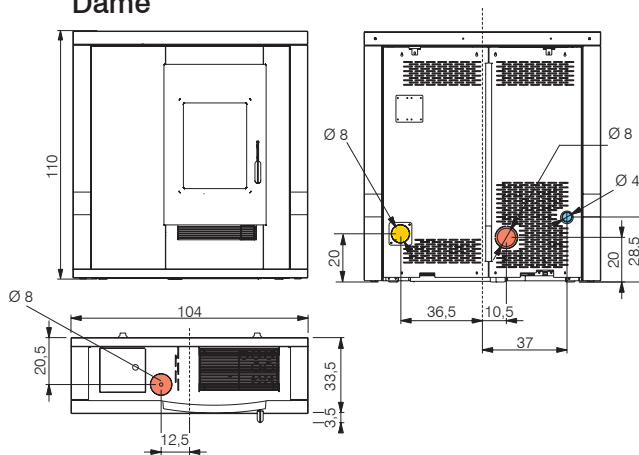

POÊLES À PELLETS_PELLETKACHELS_PELLETS-ÖFEN_PELLET STOVES

Mya Eco/Mya Air Tight
Mya Air Tight C

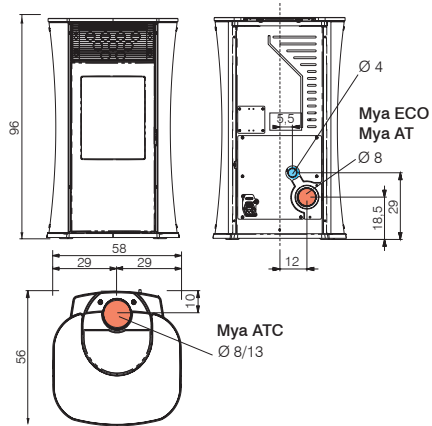

Ania Air Tight

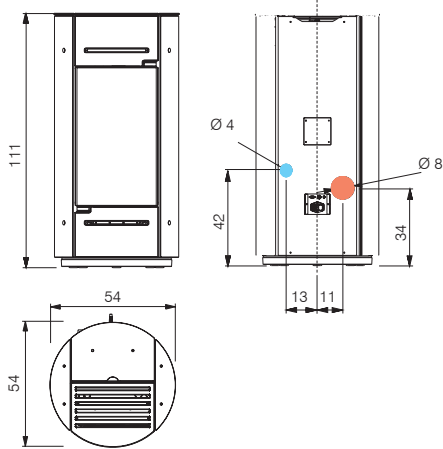

Nea Air Tight

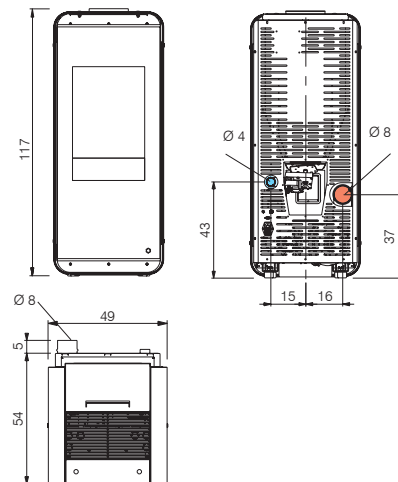

Lou Air Tight

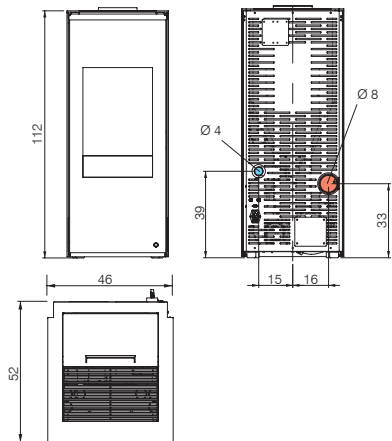

Vyda Air Tight/ Vyda Air Tight C

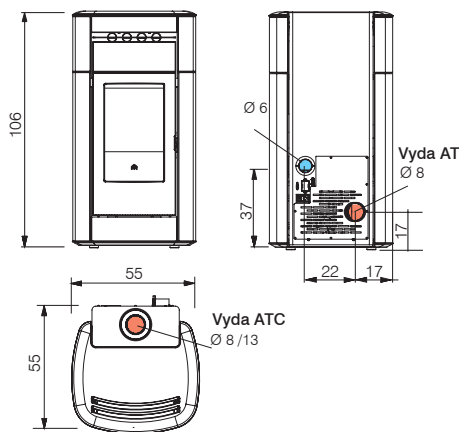

Slide/ Slide 7

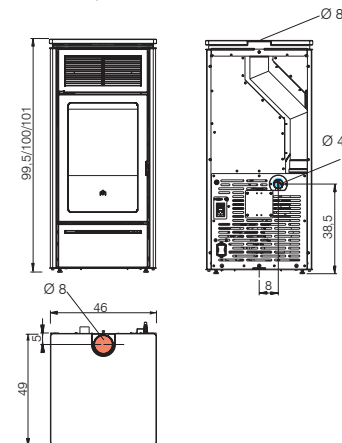

Jane

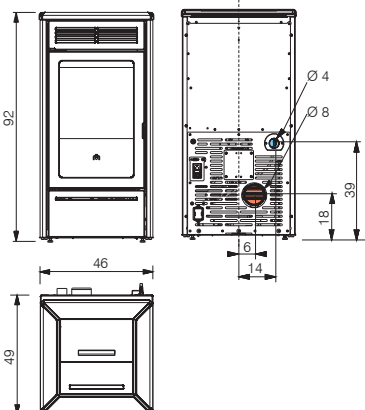

Lille

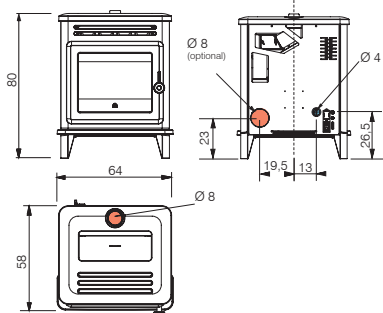

Nara/Nara Plus

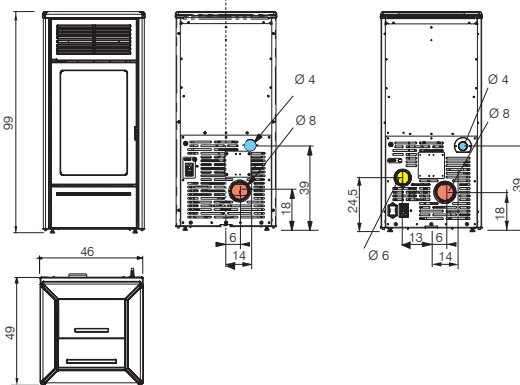

**INSERTS À PELLETS *PELLET INBOUWAARDEN*
 PELLETS-EINSÄTZE *PELLET INSERTS***

Pellkamin 8/10 *

avec tiroir (en option)/met lade (optionele)/
 mit Schublade (Sonderausstattung)/with front load tray (optional)

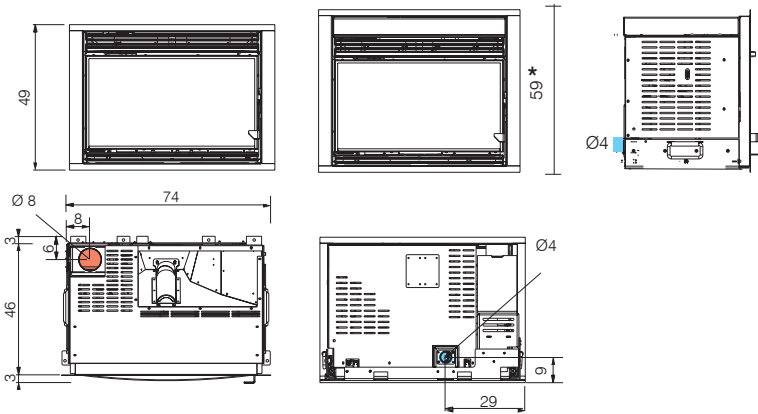

**INSERTS À BOIS *HOUT INBOUWAARDEN*
 HOLZ-EINSÄTZE *WOOD INSERTS***

Luce Plus 54/62

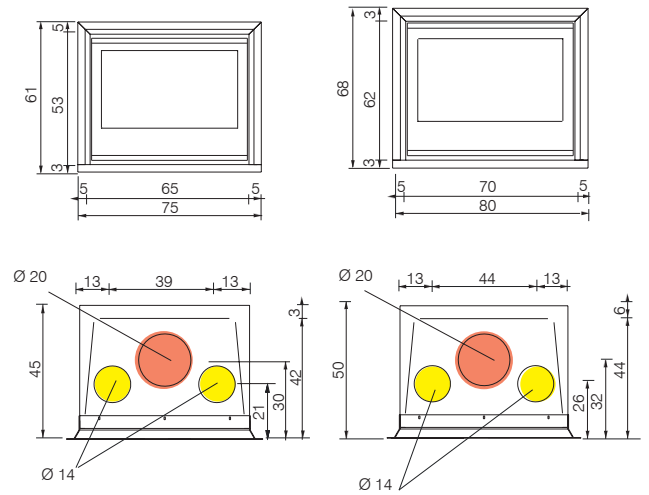

**INWOOD 70/49
 70/55**

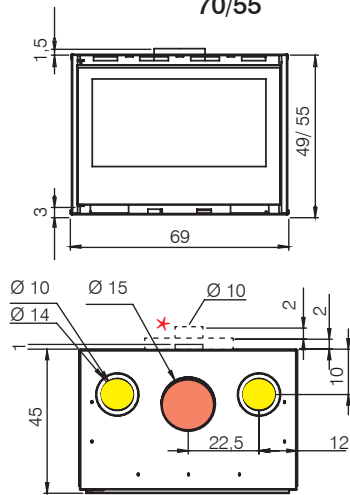

**INWOOD2 70/49
 70/55**

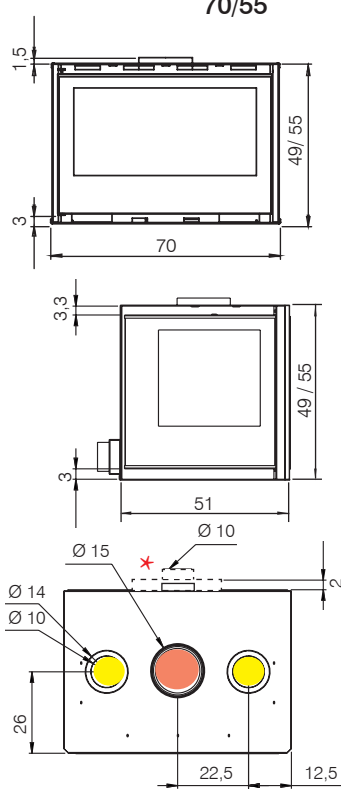

INWOOD3 70/55

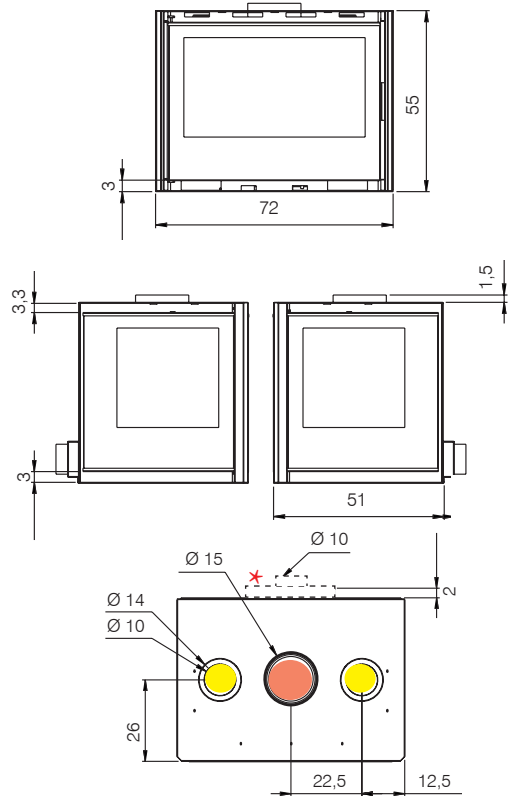

* Mécanisme prise d'air externe/
 Mechanisme voor de opname van lucht buiten/
 Außenlufteinlassmechanismus/
 External air intake mechanism

● Prise d'air externe/Externe luchttoevoer
 Aufnahme von externer Luft/External air intake

● Sortie fumées/Rookuitvoer
 Rauchauslass/Smoke outlet

● Sortié air chaud/Uitvoer warme lucht
 Ausgang für Warmluft/Hot air outlet

POÊLES À BOIS_HOUTKACHELS_HOLZOFEN_WOOD BURNING STOVES

Tally - Tally Up

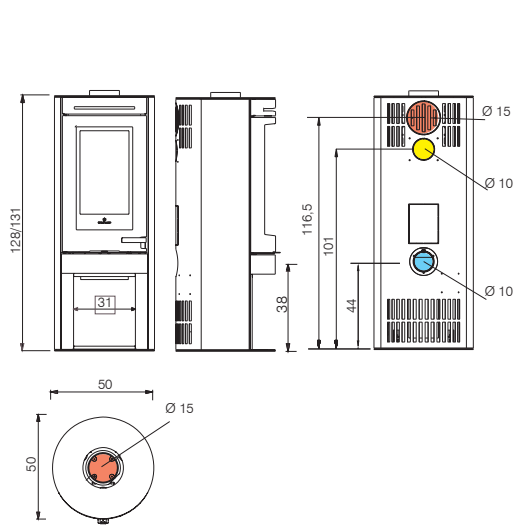

Tally S - Tally Up S

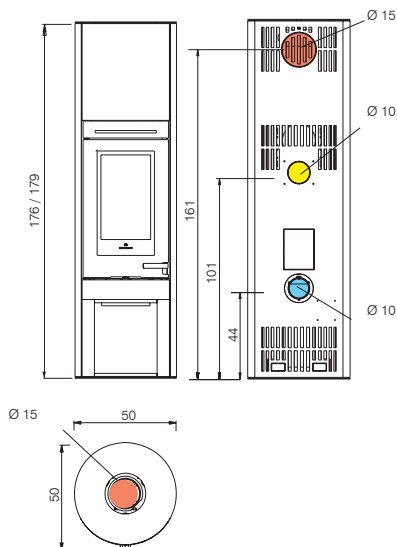

Fiord

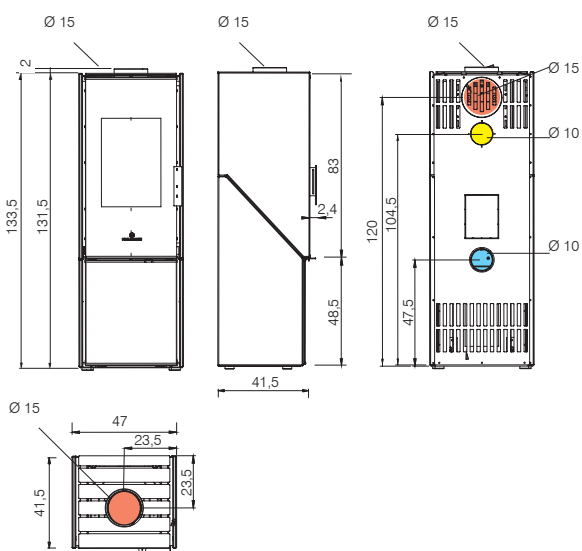

Lilia/L

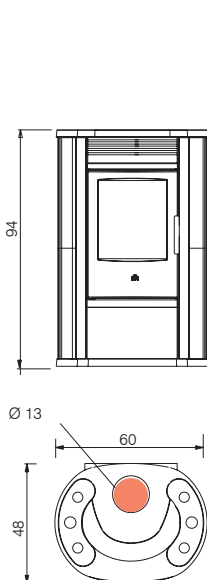

Vip, Big

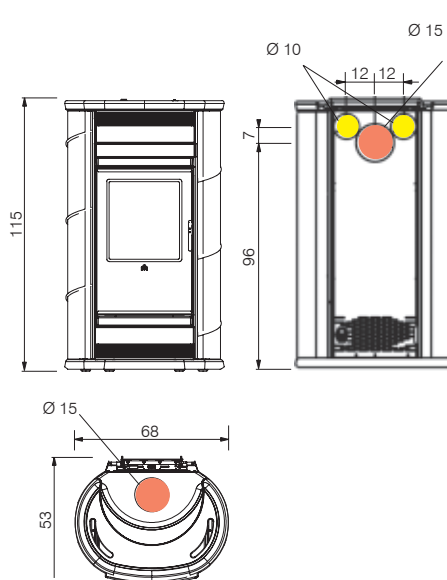

FOYERS À BOIS_HOUTHAARDEN_HOLZ-KAMINEINSÄTZE_WOOD FIREPLACES

Windo3 P50

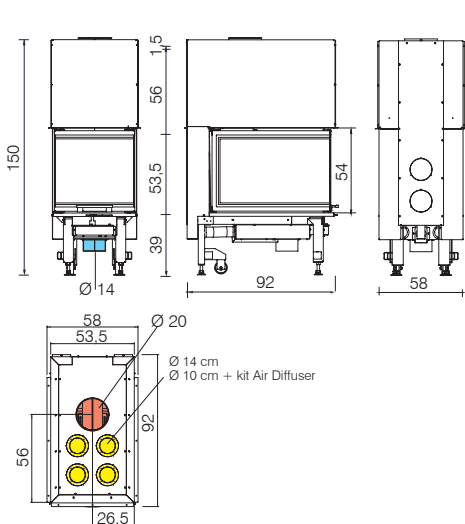

Windo2 75/95

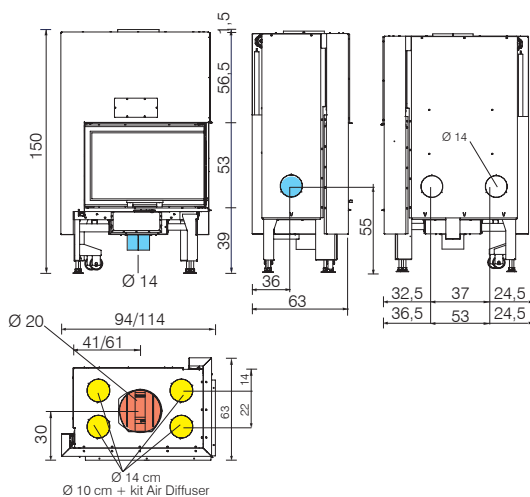

Windo3 85

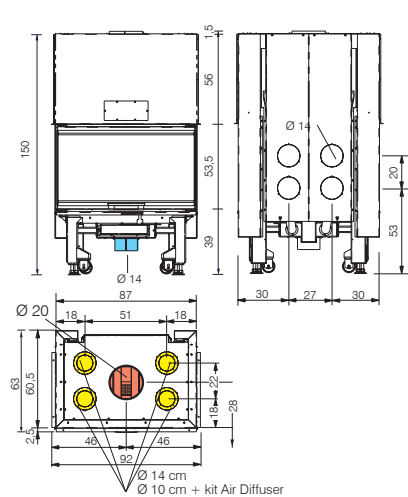

FOYERS À BOIS_HOUTHARDEN_HOLZ-KAMINEINSÄTZE_WOOD FIREPLACES

Side Plus 50x50

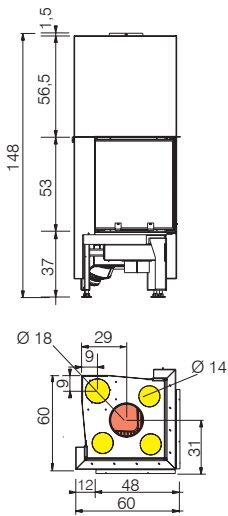

Cristal 45 N/V

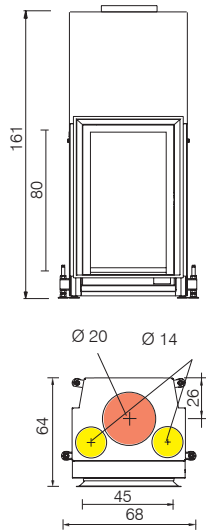

Cristal 76 N/V

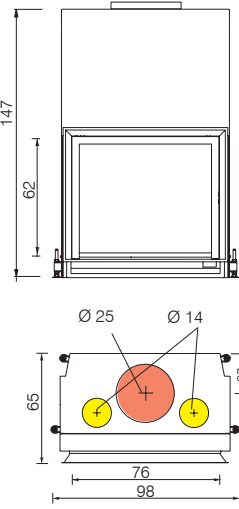

Cristal 90 N/V

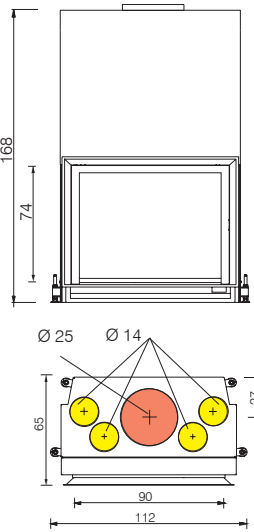

Flat 100 N/V
Flat 120 N/V

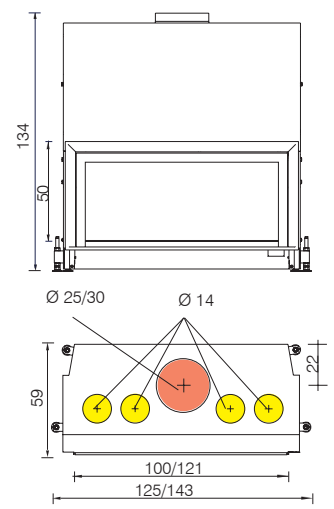

Double

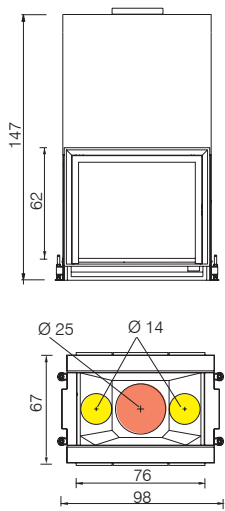

Screen Evo 80

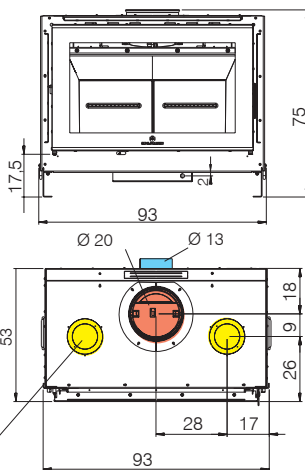

Screen Evo 100

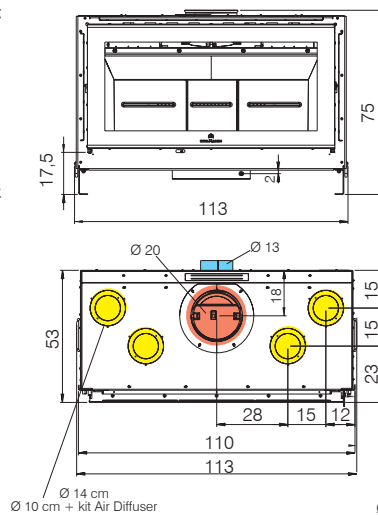

Screen Up 80/100

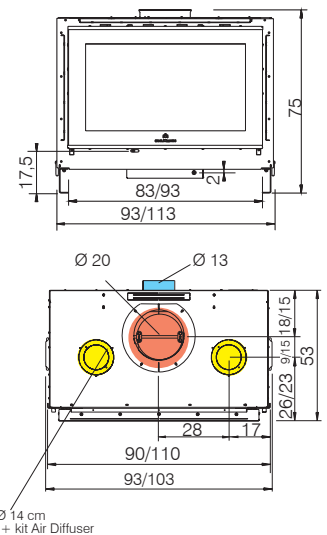

● Ø 14 cm
● Ø 10 cm + kit Air Diffuser

● Ø 14 cm
● Ø 10 cm + kit Air Diffuser

● Ø 14 cm
● Ø 10 cm + kit Air Diffuser

Status Plus

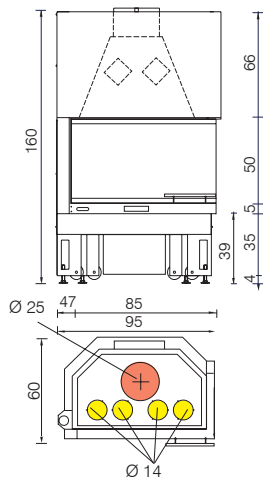

Forte Plus

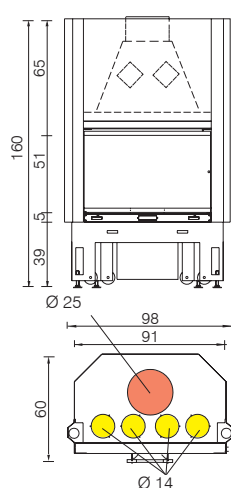

Titano Plus

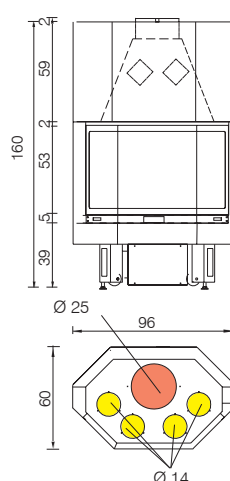

● Prise d'air externe/Externe luchttoevoer
Aufnahme von externer Luft/External air intake

● Sortie fumées/Rookuitvoer
Rauchauslass/Smoke outlet

● Sortié air chaud/Uitvoer warme lucht
Ausgang für Warmluft/Hot air outlet

CHAUDIÈRES À BOIS_HOUT CV KETELS_HOLZ-HEIZKESSEL_WOOD BOILERS

Laguna W Up

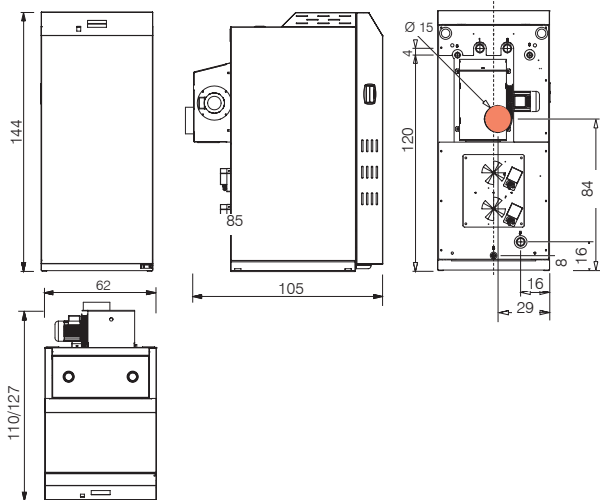

CHAUDIÈRES À PELLETS_PELLET CV KETELS_PELLETS-HEIZKESSEL_PELLET BOILERS

Laguna P 18

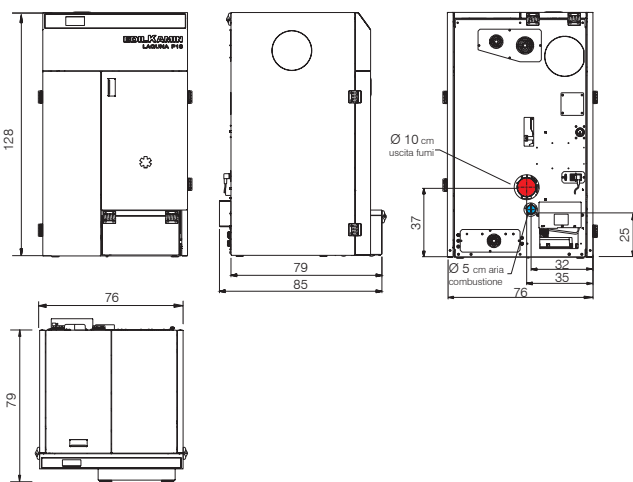

Laguna P 24/35

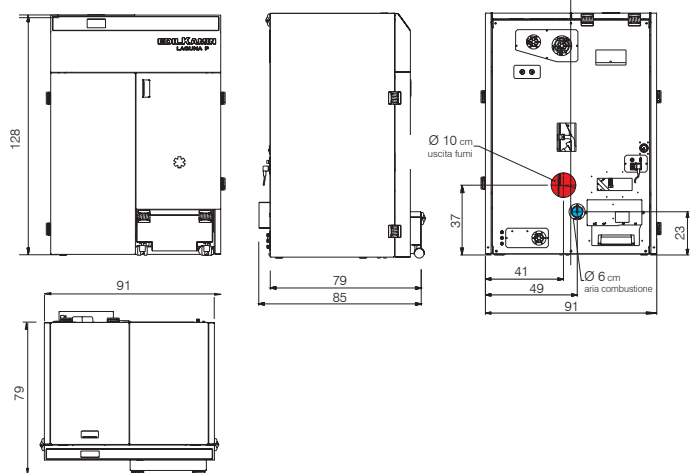

CHAUDIÈRES MULTI COMBUSTIBLES_MULTIBRANDSTOF KETELS_MEHRSTOFF-HEIZKESSEL
MULTI-FUEL BURNING BOILER

Laguna M 25/33

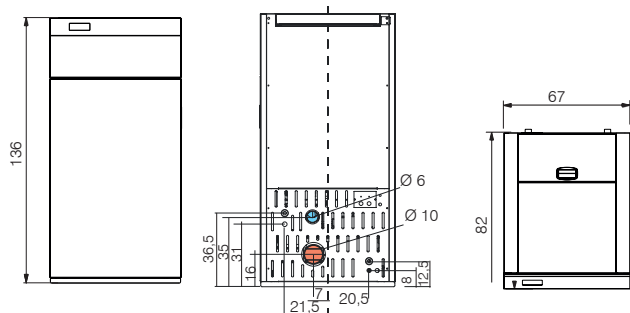

● Prise d'air externe/Externe luchttoevoer
Aufnahme von externer Luft/External air intake

● Sortie fumées/Rookuitvoer
Rauchauslass/Smoke outlet

● Sortié air chaud/Uitvoer warme lucht
Ausgang für Warmluft/Hot air outlet

**THERMOPOÊLES À BOIS CV HOUTKACHELS
WASSERGEFÜHRTE HOLZSÖFEN_
WOOD THERMO-STOVES**

Cubira

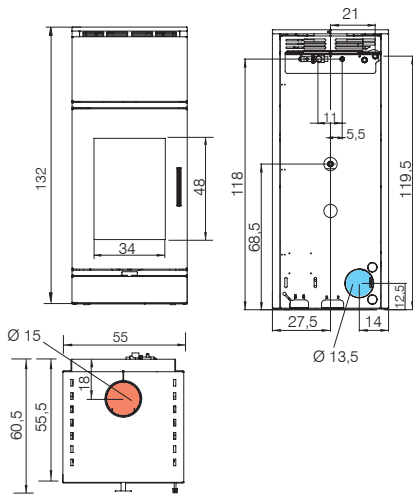

Flamma

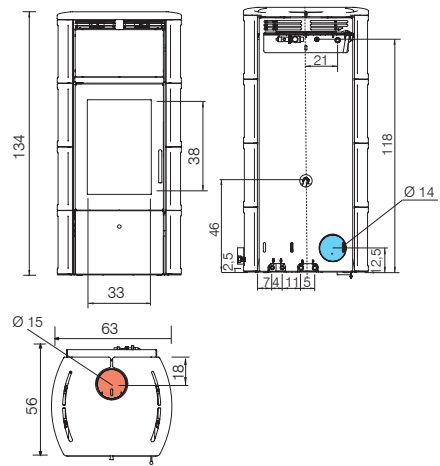

Klima / Warm

base *basis*
Grundausführung *basic*

avec chauffe-plats/met warmplaat/
Warmhalteplatte/with food warmer

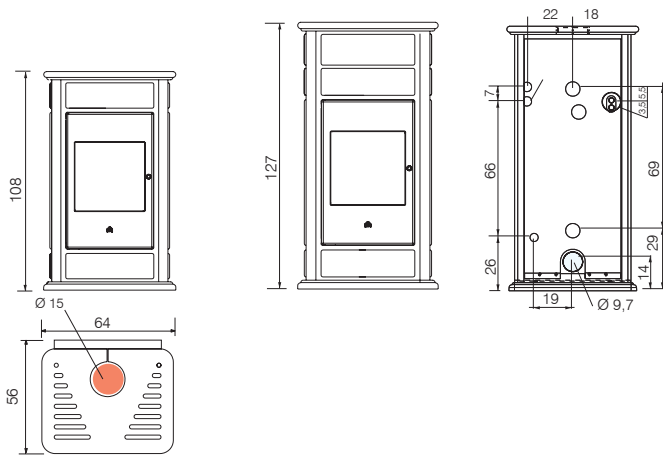

**THERMOCHEMINÉES À PELLETS CV PELLETHAARDEN
WASSERGEFÜHRTE PELLETS-KAMINEINSÄTZE *PELLET THERMO-FIREPLACES***

Idropellbox 30

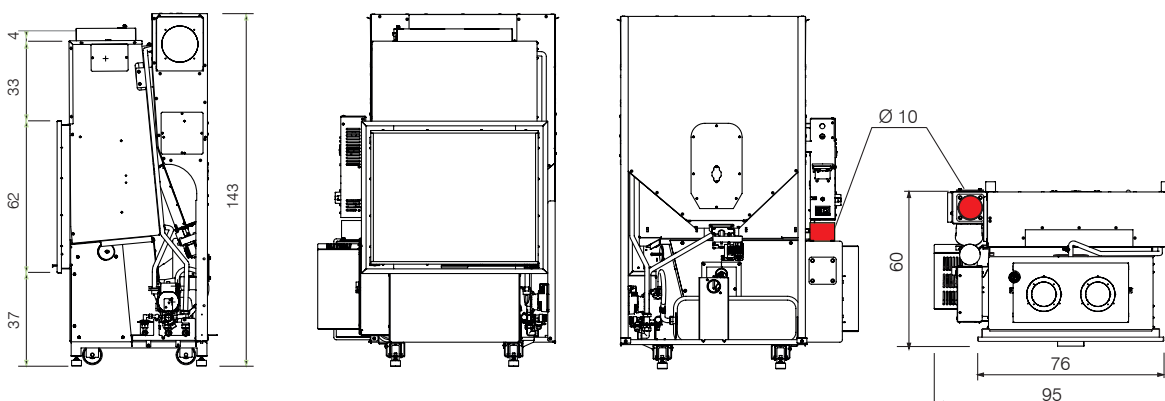

**THERMOCHEMINÉES À PELLETS CV PELLETHAARDEN
WASSERGEFÜHRTE PELLETS-KAMINEINSÄTZE PELLET THERMO-FIREPLACES**

Idropellbox

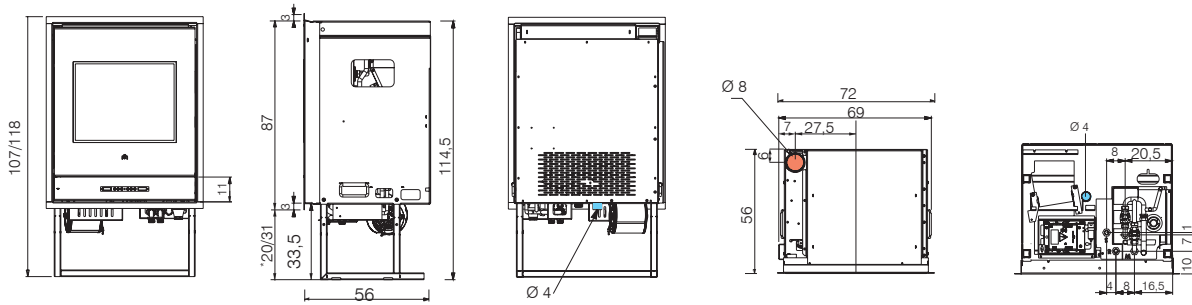

**THERMOCHEMINÉES À BOIS CV HOUTHAARDEN WASSERGEFÜHRTE HOLZ-KAMINEINSÄTZE
WOOD THERMO-FIREPLACES**

Aquamaxi 28

H2Oceano 15 / 23 / 28

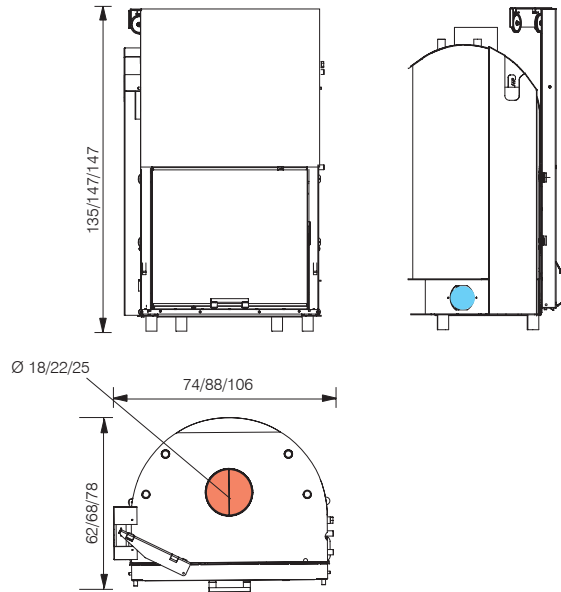
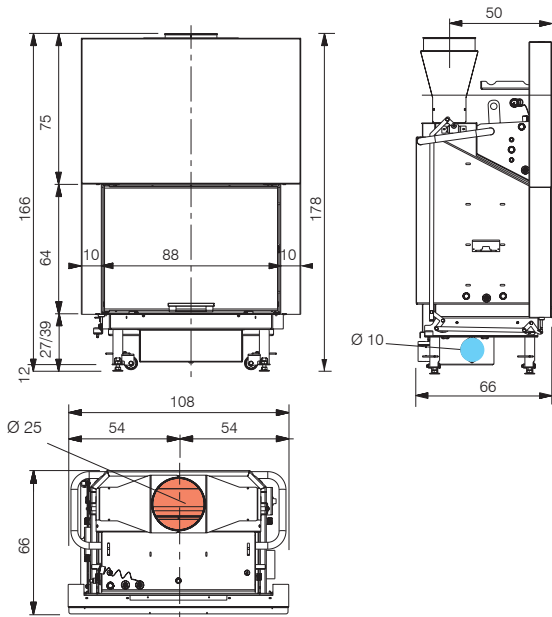

Acquatondo

Sphérique/Bol/ Sphärisch/
Curved 22

Prismatique/Prismavormig/
Prismaförmig/Prismatic 22/29

1 Côte vitré/ Een zijkant in glas
/Mit einer verglasten Seite/
Glass on one side 29

Plus 22/29

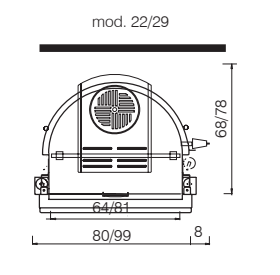
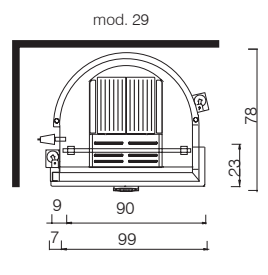
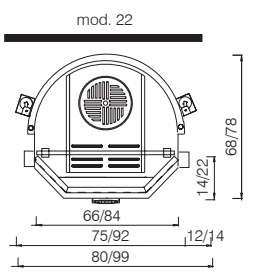
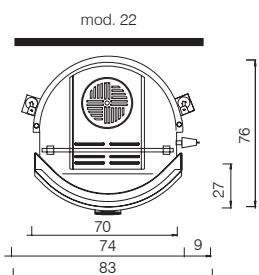
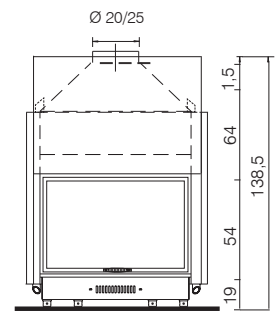
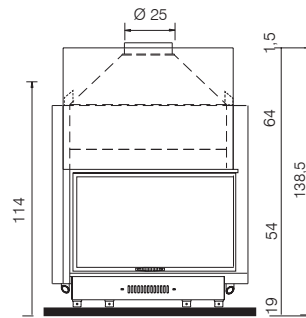
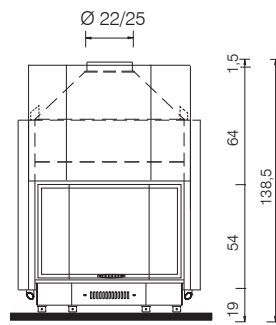
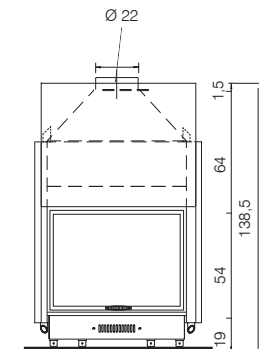

● Prise d'air externe/Externe luchttoevoer
Aufnahme von externer Luft/External air intake

● Sortie fumées/Rookuitvoer
Rauchauslass/Smoke outlet

● Sortié air chaud/Uitvoer warme lucht
Ausgang für Warmluft/Hot air outlet

SOMMAIRE_INHOUD_INHALT_INDEX

Poêle bicom bustible
Combikachel
Zweifach-Brennstoff-Ofen
Dual Combustion stove

DEMY pg 28-29

Poêles à pellets
Pelletkachels
Pellets-Öfen
Pellet stoves

ANIA Air tight pg 20-21

ARIS UP pg 38-41

ARIS UP PLUS pg 38-41

BILD pg 52-53

BILD Air tight C pg 24-25

BLADE pg 66-69

CHERIE UP pg 60-63

DAME pg 18-19

EVIA pg 48-51

JANE pg 30-31

KIKKA pg 42-43

KIRA pg 72-73

KLIK pg 44-47

LILLE pg 34-35

LOGO pg 54-55

LOU Air Tight pg 22

MYA Air Tight pg 17

MYA Air Tight C pg 17

MYA Eco pg 36-37

NARA pg 56-57

NARA PLUS pg 56-57

NEA Air Tight pg 23

SALLY pg 64-65

SALLY PLUS pg 64-65

SLIDE/SLIDE7 pg 32-33

TINY pg 58-59

VYDA pg 70-71

VYDA Air Tight pg 26

VYDA Air Tight C pg 27

Inserts à pellets
Pellet inbouwhaarden
Pellets-Einsätze
Pellet inserts

PELLKAMIN 8 pg 74-75

PELLKAMIN 10 pg 74-75

Foyers à pellets
Pellethaarden
Pellets-Kamineinsätze
Pellet fireplaces

PELLKAMIN 12 pg 76-77

Inserts à bois_Hout inbouwhaarden
Holz-einsätze_Wood inserts

LUCE PLUS pg 92-93

INWOOD pg 88-89

INWOOD2 pg 90

INWOOD3 pg 91

Poêles à bois
Houtkachels
Holz-Öfen
Wood burning stoves

BIG pg 86

FIORD pg 82-83

LILIA/L pg 84-85

TALLY pg 78-79

TALLY S pg 80-81

TALLY UP pg 79

TALLY UP S pg 81

VIP pg 87

Foyers à bois
Houthaarden
Holz-Kamineinsätze
Wood fireplaces

CRISTAL 45 pg 100

CRISTAL 76 pg 100

CRISTAL 90 pg 101

DOUBLE pg 103

FLAT 100 pg 102

FLAT 120 pg 102

FORTE PLUS pg 106

SCREEN EVO pg 104

SCREEN UP pg 104

SIDE PLUS 50X50 pg 98-99

STATUS PLUS pg 106

TITANO PLUS pg 107

WINDO2 75/95 pg 96-97

WINDO3 85 pg 94

WINDO3 P50 pg 94-95

Chaudières multi combustibles
Multibrandstof ketel
Mehrstoff-Heizkessel
Multi-fuel burning boiler

LAGUNA M 25/33 pg 139

Chaudières à pellets
Pellet CV ketels
Pellets-Heizkessel
Pellet boilers

LAGUNA P 18/24/35 pg 138

Thermopoêles à pellets
CV-pelletkachels
Wassergeführte Pellets-Öfen
Pellet thermo-stoves

BLADE H pg 126-129

BLADE H EKleaner pg 126-129

CHERIE UP H pg 116-119

DAISY pg 130-131

IDROSALLY pg 120-121

KIRA H pg 124-125

KIRA H EKleaner pg 124-125

MEG pg 132

MEG PIÙ pg 133

MITO IDRO pg 112-115

VYDA H pg 122-123

VYDA H EKleaner pg 122-123

Thermocheminées à pellets
CV pellethaarden
Wassergeführte Pellets-Kamineinsätze
Pellet thermo-fireplaces

IDROPELLBOX pg 134-135

IDROPELLBOX 30 pg 136-137

Thermopoêles à bois
CV houtkachels
Wassergeführte Holzöfen
Wood thermo-stoves

CUBIRA pg 142-143

CUBIRA CS pg 142-143

FLAMMA pg 144-145

FLAMMA CS pg 144-145

KLIMA pg 146

WARM pg 147

Chaudières à bois
Hout CV ketels
Holz-Heizkessel
Wood boilers

LAGUNA W UP pg 140

Thermocheminées à bois
CV Houthaarden
Wassergeführte Holz-Kamineinsätze
Wood thermo-fireplaces

ACQUATONDO pg 152-153
AQUAMAXI 28 pg 150-151
H2OCEANO pg 148-149

Revêtements
Bekledingen
Verkleidungen
Coverings

AIR pg 154
ARABESQUE pg 154
BIX BOX pg 154
BIX BOX 62 pg 154
BIX BOX 100 pg 154
DROMOND pg 155
FAIR pg 155
GREY UP pg 156
HIGH TECH pg 156
INCAS pg 156
IRON pg 156
LASER pg 156
LIFE pg 157
MEXICO pg 157
NICE pg 157
SAHARA pg 158
SAHARA 100 pg 158
SILVER pg 159
SMILE pg 159
SQUARE pg 159
SWEET pg 158
WELL pg 159

EDILKAMIN S.p.A.

Se réserve la faculté de modifier à tout moment, sans préavis, les caractéristiques techniques et esthétiques des éléments illustrés et décline toute responsabilité pour d'éventuelles erreurs d'impression présentes dans le catalogue.

We behouden ons de mogelijkheid voor op elk gewenst moment zonder aankondiging de technische eigenschappen en het aanzicht van de onderdelen te wijzigen. We achten ons niet verantwoordelijk voor eventuele drukfouten in de catalogus.

Der Hersteller behält sich das Recht vor, ohne Vorankündigung die technischen und ästhetischen Merkmale der im vorliegenden Katalog abgebildeten Elemente jederzeit zu ändern. Er übernimmt keine Haftung für eventuelle Druckfehler.

Reserves the right to change the technical and aesthetic specifications of the components illustrated in this catalogue, at any time and without prior notice and declines all responsibility for any printing errors in this catalogue.



**IO SONO
IL FUOCO**



EDILKAMIN
STUFE_CALDAIE_CAMINETTI



www.edilkamin.com
export@edilkamin.com

EI 945496 120.06.18/B

